

---

# User's Guide

Publication number 16500-97007  
First Edition, February 1994

For Safety information, Warranties, and Regulatory  
information, see the pages behind the index

© Copyright Hewlett-Packard Company 1987, 1990, 1993, 1994  
All Rights Reserved

---

## HP 16500B /16501A Logic Analysis System

---

# HP 16500B—At a Glance

### A system of measurement modules

The HP 16500B is the mainframe of the Hewlett-Packard Logic Analysis System. It offers a modular structure for plug-in cards with a wide range of state, timing, oscilloscope, and pattern generator capabilities.

### A powerful, easy-to-use interface

The touchscreen interface offers pop-up menus and color graphics to lead you through measurement configurations without having to remember lots of steps. You can add a keyboard or mouse to speed data input and measurement configuration.

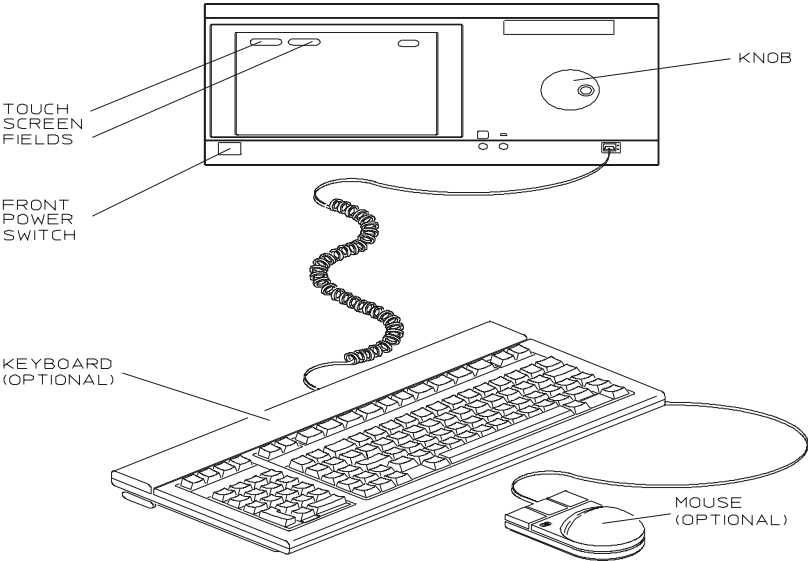

16515E65

### The HP 16501A expands module capacity

The HP 16501A is the add-on mainframe for expanding the module capacity of the HP 16500B. When the two are connected, they form a single ten-card system that is turned on and controlled by the HP 16500B.

### Intermodule measurement capability

The HP 16500B offers intermodule measurement features that allow you to capture complex system activity. Modules can

- be armed by an external instrument,
- be armed by another module in the HP16500B or HP16501A frames, or
- be used to arm an external instrument.

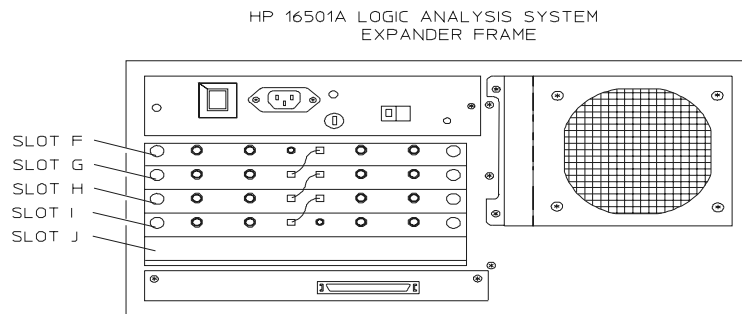
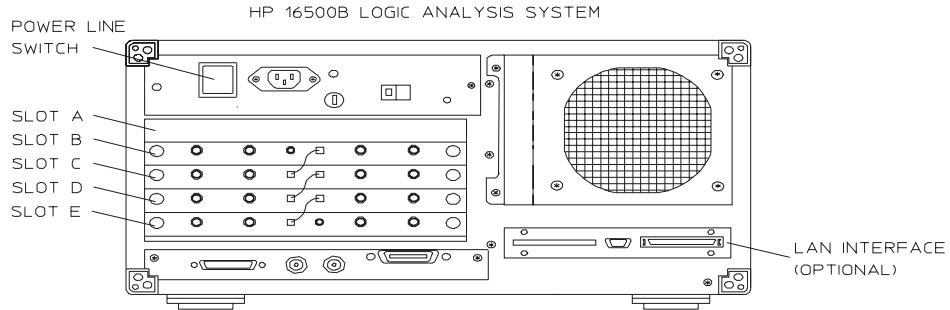

16500E71

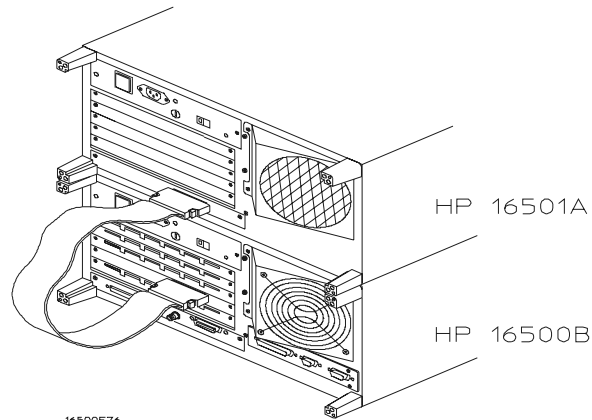

16500E76

### Install measurement modules in any slot

Single card analyzers, oscilloscopes, and other options can go in any slot of the HP 16500B or HP 16501A. You should generally begin installing cards starting with the bottom-most slot and working up.

Some measurement modules have multiple cards. A multiple-card module must be installed into adjacent slots in the same mainframe—that is, you cannot install one card of the module into the HP 16500B and the other into the HP 16501A.

### Calibrate measurement modules after installation

Some measurement modules are sensitive to temperature and voltage variations between different mainframes. Thus, when you install such a module in the mainframe, you should calibrate it before using it to ensure maximum measurement precision and accuracy.

See the Service Guide for each measurement module for installation and calibration procedures.

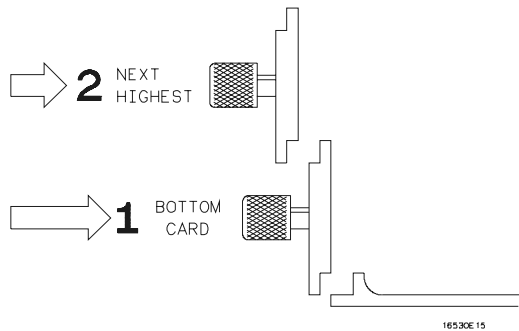
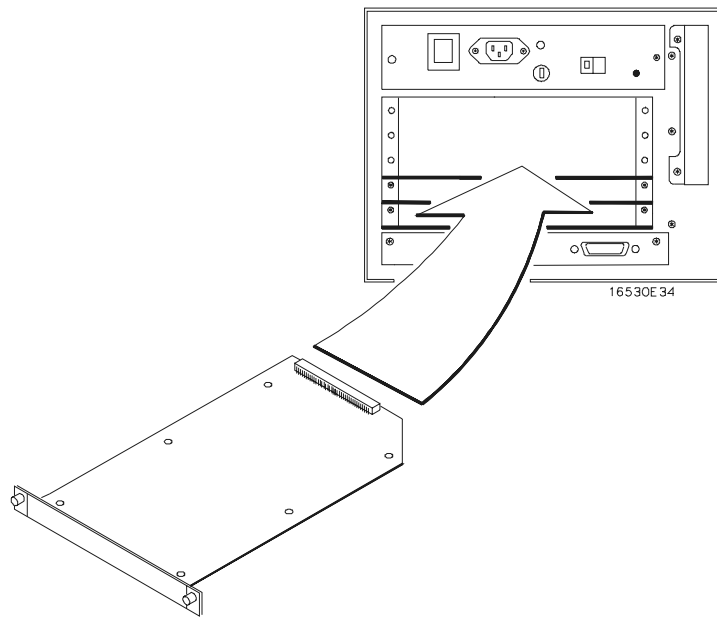

---

## In This Book

This *User's Guide* shows you how to use the HP 16500B Logic Analysis System in your everyday debugging work.

Chapter 1, "Triggering," shows you how to set up the analyzer to trigger on the various kinds of events present in your system. Advanced triggering capability allows you to look at only the program states of interest when you are solving a particular problem.

Chapter 2, "Intermodule Measurements," shows you how to configure multiple HP 16500 modules and external measurement instruments into a single measurement system in which modules trigger each other.

Chapter 3, "File Management," shows you how to transfer files to and from the HP 16500B using flexible disks, LAN interfaces, and other interfaces.

Chapter 4, "Concepts," gives you a brief introduction to the ideas underlying the trigger sequencer and the inverse assembler, two important components of sophisticated logic analysis.

Chapter 5, "Solving Problems," shows you how to diagnose and correct the more common types of problems that might occur while you are making a measurement.

Chapter 6, "Application Notes," lists the various application notes that HP has published regarding the HP 16500B and other similar HP logic analyzers. These

1	Triggering	
2	Intermodule Measurements	
3	File Management	
4	Concepts	
5	Solving Problems	
6	Application Notes	
	Glossary	
	Index	

notes will give you more information about specific application problems and how to solve them using an HP logic analyzer.



**See Also**

For general information on setup and operation of the HP 16500B, see the *HP 16500B/16501A Logic Analysis System User's Reference*.

For information on programming the HP 16500B using a computer controller such as a workstation or personal computer, see the *HP 16500B/16501A Logic Analysis System Programmer's Guide*.

For information on logic analyzers, oscilloscopes, preprocessors, and other logic analysis system options, see the *User's Reference* manual for those options.

---

# Contents

## 1 Triggering

- To store and time the execution of a subroutine 1-3
- To trigger on the nth iteration of a loop 1-5
- To trigger on the nth recursive call of a recursive function 1-7
- To trigger on entry to a function 1-9
- To capture a trace of activity associated with a write of known bad data to a particular variable 1-11
- To trigger on a loop that occasionally runs too long 1-12
- To verify that all stacks and registers are restored correctly before exiting a subroutine 1-13
- To trigger after all status bus lines finish transitioning 1-15
- To find the nth occurrence of asserting a chip select line 1-16
- To verify that the chip select line of a memory chip is strobed after the address on the address bus is stable 1-17
- To trigger when expected data does not appear on the data bus from a remote device when requested 1-18
- To test minimum and maximum pulse limits 1-20
- To detect a handshake violation 1-22
- To detect bus contention 1-23
  
- Cross-Arming Trigger Examples 1-24
- To examine software execution when a timing violation occurs 1-25
- To look at control and status signals during execution of a routine 1-26

## 2 Intermodule Measurements

- Intermodule Measurement Examples 2-4
- To set up a group run of modules within the HP 16500B 2-5
- To start a group run of modules from an external trigger source 2-7
- To start an external instrument on command from a module within the HP 16500 and 16501 mainframe 2-9
- To see the status of a module within an intermodule measurement 2-11
- o see time correlation of each module within an intermodule measurement 2-12
- To use a timing analyzer to detect a glitch 2-13

- To capture the waveform of a glitch 2-14
- o capture state flow showing how your target system processes an interrupt 2-15
- Using stimulus-response to test a circuit 2-17
- To use a state analyzer to trigger timing analysis of a count-down on a set of data lines 2-19
- To use two state analyzers to monitor the activity of coprocessors in a target system 2-20
  
- Special displays 2-21
- To interleave trace lists 2-22
- To view trace lists and waveforms together on the same display 2-24
  
- Skew Adjustment 2-26
- To adjust for minimum skew between two modules involved in an intermodule measurement 2-27

### **3 File Management**

- Transferring Files Using the Flexible Disk Drive 3-3
- To save a measurement configuration 3-4
- To load a measurement configuration 3-6
- To save a trace list in ASCII format 3-8
- To save a menu or measurement as a graphic image 3-10
- To load system software 3-12
  
- Using the HP 16500L LAN Interface 3-13
- To set up the HP 16500B 3-14
- To transfer data files from the HP 16500B system to your computer 3-16
- To transfer graphics files from the HP 16500B system to your computer 3-18

### **4 Concepts**

- The Trigger Sequencer 4-3



The Inverse Assembler 4-10

Configuration Translation for Analyzer Modules 4-13

## **5 If You Have a Problem**

Analyzer Problems 5-3

Intermittent data errors 5-3

Unwanted triggers 5-3

No Setup/Hold field on format screen 5-4

No activity on activity indicators 5-4

Capacitive loading 5-4

No trace list display 5-5

Preprocessor Problems 5-6

Target system will not boot up 5-6

Slow clock 5-7

Erratic trace measurements 5-7

Inverse Assembler Problems 5-9

No inverse assembly or incorrect inverse assembly 5-9

Inverse assembler will not load or run 5-10

Intermodule Measurement Problems 5-11

An event wasn't captured by one of the modules 5-11

Messages 5-12

“Default Calibration Factors Loaded” (HP 16540, 16541, and 16542) 5-12

“. . . Inverse Assembler Not Found” 5-12

“Measurement Initialization Error” 5-13

“No Configuration File Loaded” 5-14

“Selected File is Incompatible” 5-14

“Slow or Missing Clock” 5-14

“State Clock Violates Overdrive Specification” 5-15

“Time from Arm Greater Than 41.93 ms” 5-15

Contents

“Waiting for Trigger” 5-15

**6 Application Notes**



Triggering

---



## Triggering

As you begin to understand a problem in your system, you may realize that certain conditions must occur before the problem occurs. You can use sequential triggering to ensure that those conditions have occurred before the analyzer recognizes its trigger and captures information.

You set up sequential triggering as follows:

- Select the Trigger menu for the module you are using.
- In the Trigger menu, define terms and associated values to be used when searching through the sequence.
- In the Trigger menu, select the number of the state sequence level you want to modify, and enter the appropriate store qualification, sequence-advance specification, and sequence-Else specification.

If you aren't familiar with the trigger menus, try working through the examples in the *Logic Analyzer Training Kit* manual, or refer to the *User's Reference* for your analyzer.



---

## To store and time the execution of a subroutine

Most systems software of any kind is composed of a hierarchy of functions and procedures. During integration, testing, and performance evaluation, you will want to look at specific procedures to verify that they are executing correctly and that the implementation is efficient. The analyzer allows you to do this by triggering on entry to the address range of the subroutine and counting the elapsed time since the trigger state.

**1 Select the state analyzer Trigger menu.**

**2 Set Count to Time.**

Setting the Count to Time causes the state analyzer to store a time stamp for each data point that is stored in trace memory. The trace list will show these time stamps next to each state.

**3 Define a range term, such as Range1, to represent the address range of the subroutine of interest.**

You may need to examine the structure of your code to help determine this. If your subroutine calls are really procedure calls, then there is likely to be some code at the beginning of the routine that adjusts the stack for local variable allocation. This will precede the address of the first statement in the procedure. If your subroutine has no local storage and is called by a jump or branch, then the first statement will also be the entry address.

**4 Under State Sequence Levels, enter the following sequence specification:**

- While storing “no state” Trigger on “In\_range1” 1 time
- While storing “In\_range1” Then find “Out\_range1” 1 time
- Store “no state”

---

**Example**

Suppose you want to trigger on entry to a routine called MY\_SUB. You can define the address of MY\_SUB in the Format menu, allowing you to reference the symbol name when setting up the trace specification. Assume that MY\_SUB extends for 0A hex locations. You can set up the trigger sequencer as shown in the display.

Triggering  
To store and time the execution of a subroutine



100/500MHz LA B		Trigger 1		Print	Run
State Sequence Levels				Timer	Arming Control
1	While storing "no state"	TRIGGER on "In_range1" 1 time	- -	- -	Acquisition Control
2	While storing "In_range1"	Then find "Out_range1" 1 time	- -	- -	Count Time
3	Store "no state"		- -	- -	Clear Trigger
+Label+	ADDR				
+Terms+	Symbol				
Range1					
upper	HY_SUB +0000A				
lower	HY_SUB +00000				

Trigger Setup for Storing Execution of a Subroutine

For processors that do prefetching of instructions or have pipelined architectures, you may want to add part or all of the depth of the pipeline to the start address for In\_Range1 to ensure that the analyzer does not trigger on a prefetched but unexecuted state.



---

## To trigger on the nth iteration of a loop

Traditional debugging requires print statements around the area of interest. This is not possible in most embedded systems designs. But, the analyzer allows you to view the system's behavior when a particular event occurs. Suppose that your system behaves incorrectly on the last iteration of a loop, which, in this instance, happens to be the 10th iteration. You can use the analyzer's triggering capabilities to capture that iteration and subsequent processor activity.

- 1** Select the state analyzer Trigger menu.
- 2** Define the terms LP\_START and LP\_END to represent the start and end addresses of statements in the loop, and LP\_EXIT to represent the first statement executed after the loop terminates.
- 3** Under State Sequence Levels, enter the following sequence specification:
  - While storing "no state" Find LP\_END 1 time
  - While storing "anystate" TRIGGER on LP\_START 9 times; Else on "LP\_EXIT" go to level 1
  - Store "anystate"

The above sequence specification has some advantages and a potential problem. The advantages are that a pipelined processor won't trigger until it has executed the loop 10 times. Requiring LP\_END to be seen at least once first ensures that the processor actually entered the loop; then, 9 more iterations of LP\_START is really the 10th iteration of the loop. Also, no trigger occurs if the loop executes less than 10 times: the analyzer sees LP\_EXIT and restarts the trigger sequence. The potential problem is that LP\_EXIT may be too near LP\_END and thus appear on the bus during a prefetch. The analyzer will constantly restart the sequence and will never trigger. The solution to this problem depends on the structure of your code. You may need to experiment with different trigger sequences to find one that captures only the data you wish to view.

Triggering  
 To trigger on the nth iteration of a loop



100/500MHz LA B      Trigger 1      Print      Run

State Sequence Levels		Timer		
Level	Description	1	2	Control
1	While storing "no state" Find "LP_END" 1 time	-	-	Arming Control
2	While storing "anystate" TRIGGER on "LP_START" 9 times Else on "LP_EXIT" go to level 1	-	-	Acquisition Control
3	Store "anystate"	-	-	Count Time
				Clear Trigger

Label	ADDR	DATA	STAT	R/W	SIZE
Terms	Symbol	Hex	Symbol	Hex	Hex
LP_START	absolute 124B7	XXXX	absolute XXXX	X	X
LP_END	absolute 12EB3	XXXX	absolute XXXX	X	X
LP_EXIT	absolute 132DC	XXXX	absolute XXXX	X	X
d	absolute 0XXXX	XXXX	absolute XXXX	X	X

Trigger Setup for Triggering on the 10th Iteration of a Loop





---

## To trigger on the nth recursive call of a recursive function

- 1 Select the state analyzer Trigger menu.
- 2 Define the terms CALL\_ADD, F\_START, and F\_END to represent the called address of the recursive function, and the start and end addresses of the function. Define F\_EXIT to represent the address of the first program statement executed after the original recursive call has terminated.

Typically, CALL\_ADD is the address of the code that sets up the activation record on the stack, F\_START is the address of the first statement in the function, and F\_END is the address of the last instruction of the function, which does not necessarily correspond to the address of the last statement. If the start of the function and the address called by recursive calls are the same, or you are not interested in the function initialization code, you can use F\_START for both CALL\_ADD and F\_START.

- 3 Under State Sequence Levels, enter the following sequence specification:

- While storing “no state” Find “F\_END” 1 time
- While storing “anystate” Then find “F\_START” 1 time
- While storing “anystate” TRIGGER on “CALL\_ADD” 20 times Else on “F\_EXIT” go to level 1
- Store “anystate”

As with the trigger specification for “To trigger on the nth iteration of a loop,” this specification helps avoid potential problems on pipelined processors by requiring that the processor already be in the first recursive call before advancing the sequencer. Depending on the exact code used for the calls, you may need to experiment with different trigger sequences to find one that captures only the data you wish to view.

Triggering  
 To trigger on the nth recursive call of a recursive function



100/500MHz LA B      Trigger 1      Print      Run

+ State Sequence Levels +

	Timer	1	2	Arming Control
1 While storing "no state" Find "F_END" 1 time	--			Arming Control
2 While storing "anystate" Then find "F_START" 1 time	--			Acquisition Control
3 While storing "anystate" TRIGGER on "CALL_ADD" 20 times Else on "F_EXIT" go to level 1	--			Count Time
				Clear Trigger

+ Label +	ADDR	DATA	STAT	R/~W	SIZ
+ Terms +	Symbol	Hex	Symbol	Hex	Hex
F_START	absolute 124B7	XXXX	absolute XXXX	X	X
F_END	absolute 12EB3	XXXX	absolute XXXX	X	X
F_EXIT	absolute 132DC	XXXX	absolute XXXX	X	X
CALL_ADD	absolute 1255A	XXXX	absolute XXXX	X	X

Triggering on the 22nd Call of a Recursive Function



---

## To trigger on entry to a function

This sequence triggers on entry to a function only when it is called by one particular function.

- 1** Select the state analyzer Trigger menu.
- 2** Define the terms F1\_START and F1\_END to represent the start and end addresses of the calling function. Define F2\_START to represent the start address of the called function.
- 3** Under State Sequence Levels, enter the following sequence specification:
  - While storing “anystate” Find “F1\_START” 1 time
  - While storing “anystate” TRIGGER on “F2\_START” 1 time Else on “F1\_END” go to level 1
  - Store “anystate”

This sequence specification assumes there is some conditional logic in function F1 that chooses whether or not to call function F2. Thus, if F1 ends without the analyzer having seen F2, the sequence restarts.

The specification also stores all execution inside function F1, whether or not F2 was called. If you are interested only in the execution of F1, without the code that led to its invocation, you can change the storage specification from “anystate” to “nostate” for the second sequence term.

Triggering  
 To trigger on entry to a function



100/500MHz LA B
Trigger 1
Print
Run

	State Sequence Levels	Timer	
1	While storing "anystate" Find "F1_START" 1 time	1 -	Arming Control
2	While storing "anystate" TRIGGER on "F2_START" 1 time Else on "F1_END" go to level 1	- -	Acquisition Control
3	Store "anystate"	- -	Count Time
			Clear Trigger

+ Label +	ADDR	DATA	STAT	R/-W	SIZ
+ Terms +	Symbol	Hex	Symbol	Hex	Hex
F1_START	absolute 124B7	XXXX	absolute XXXX	X	X
F1_END	absolute 12EB3	XXXX	absolute XXXX	X	X
F2_START	absolute 132DC	XXXX	absolute XXXX	X	X
D	absolute 00000	000C	absolute 0000	0	0

Triggering on Entry to a Function

particular variable

## To capture a trace of activity associated with a write of known bad data to a particular variable

The trigger specification ANDs the bad data on the data bus, write transaction on the status bus, and address of the variable on the address bus.

- 1 Select the state analyzer Trigger menu.
- 2 Define the terms BAD\_DATA, WRITE, and VAR\_ADDR to represent the bad data value, write status, and the address of the variable.
- 3 Under State Sequence Levels, enter the following sequence specification:
  - While storing “anystate” TRIGGER on “BAD\_DATA • WRITE • VAR\_ADDR” one time (you use the Combination trigger term to do this)
  - Store “anystate”

The screenshot shows the State Analyzer Trigger menu with the following configuration:

IOC/500MHz LA B    Trigger 1    Print    Run

State Sequence Levels

Level	Specification	Timer 1	Timer 2
1	While storing "anystate" TRIGGER on "BAD_DATA•WRITE•VAR_ADDR" 1 time	--	--
2	Store "anystate"	--	--

Control buttons: Arming Control, Acquisition Control, Count Time, Clear Trigger

Label	ADDR	DATA	STAT	R/W	SIZE
BAD_DATA	absolute XXXXX	A562	absolute XXXX	X	X
WRITE	absolute XXXXX	XXXX	absolute XXXX	0	X
VAR_ADDR	absolute 1320C	XXXX	absolute XXXX	X	X
D	absolute 00000	0000	absolute 0000	0	0

Capturing a Bad Write to a Variable

## To trigger on a loop that occasionally runs too long

This example assumes the loop normally executes in 14  $\mu$ s.

- 1 Select the state analyzer Trigger menu.
- 2 Define terms LP\_START, LP\_END, and Timer1 to represent the start and end addresses of the loop, and the normal duration of the loop.

You can make the sequence specification closer to the problem domain by renaming Timer1 to LOOP\_DUR.

- 3 Under State Sequence Levels, enter the following sequence specification:

- While storing "anystate" Find "LP\_START" 1 time
- While storing "anystate" TRIGGER on "LOOP\_DUR > 14.00  $\mu$ s" 1 time Else on "LP\_END" go to level 1

You will need to start the LOOP\_DUR timer (Timer1) upon entering this state. You do this using the Timer Control field in the menu for sequence level 2.

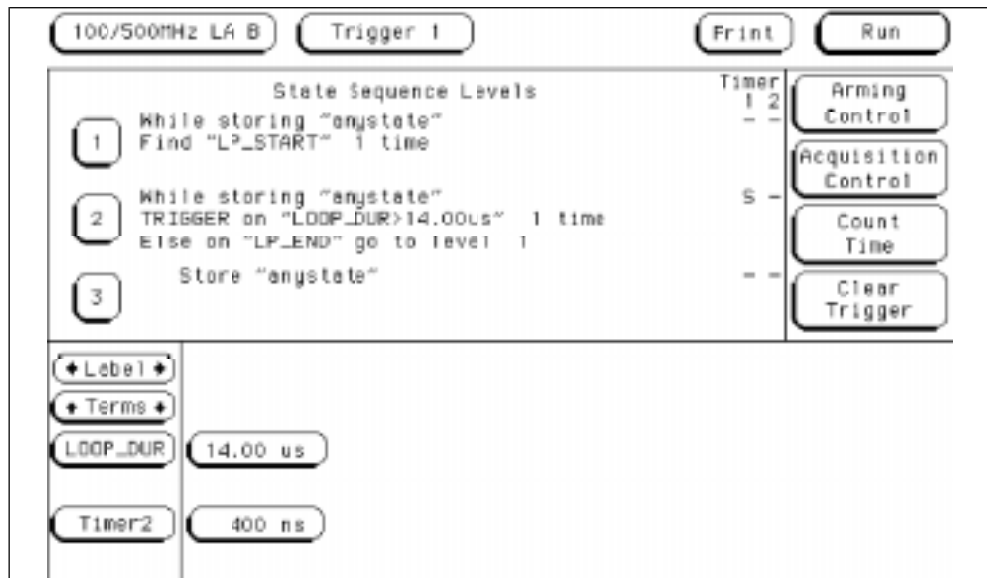

- Store "anystate"

subroutine

Triggering on a Loop Overrun

## To verify that all stacks and registers are restored correctly before exiting a subroutine

The exit code for a function will often contain instructions for deallocating stack storage for local variables and restoring registers that were saved during the function call. Some language implementations vary on these points, with the calling function doing some of this work, so you may need to adapt the procedure to suit your system.

- 1 Select the state analyzer Trigger menu.
- 2 Define terms SR\_START and SR\_END to represent the start and end addresses of the subroutine.
- 3 Under State Sequence Levels, enter the following sequence specification:
  - While storing "anystate" Find "SR\_START" 1 time
  - While storing "anystate" Then find "SR\_END" 1 time
  - While storing "anystate" TRIGGER on "≠ SR\_START" 1 time Else on

Label	ADDR	DATA	STAT	R/W	SIZE
SR_START	absolute 1567A	X0XX	absolute XXXX	X	X
SR_END	absolute 16001	X0XX	absolute XXXX	X	X
C	absolute XXXXX	X0XX	absolute XXXX	X	X
D	absolute 00000	0C00	absolute 0900	0	0

"SR\_START" go to level 2



Triggering

**To verify that all stacks and registers are restored correctly before exiting a subroutine**

- Store “anystate”

**Verifying Correct Return from a Function Call**

Only three sequence terms are shown on the display at a time. You can scroll through the terms using the knob when the “State Sequence Levels” field is light blue.





---

## To trigger after all status bus lines finish transitioning

In some applications, you will want to trigger a measurement when a particular pattern has become stable. For example, you might want to trigger the analyzer when a microprocessor's status bus has become stable during the bus cycle.

- 1 Select the timing analyzer Trigger menu and define a term called PATTERN to represent the value to be found on the label representing the status bus lines.
- 2 Under Timing Sequence Levels, enter the following sequence specification:  
TRIGGER on "PATTERN" > 40 ns

---

## To find the nth occurrence of asserting a chip select line

- 1 Select the timing analyzer Trigger menu.
- 2 Define the glitch/edge1 term to represent the asserting transition on the chip select line.

You can rename the Edge1 term to make it correspond more closely to the problem domain, for example, to CHIP\_SEL.

- 3 Under Timing Sequence Levels, enter the following sequence specification:

TRIGGER on "CHIP\_SEL" 10 times

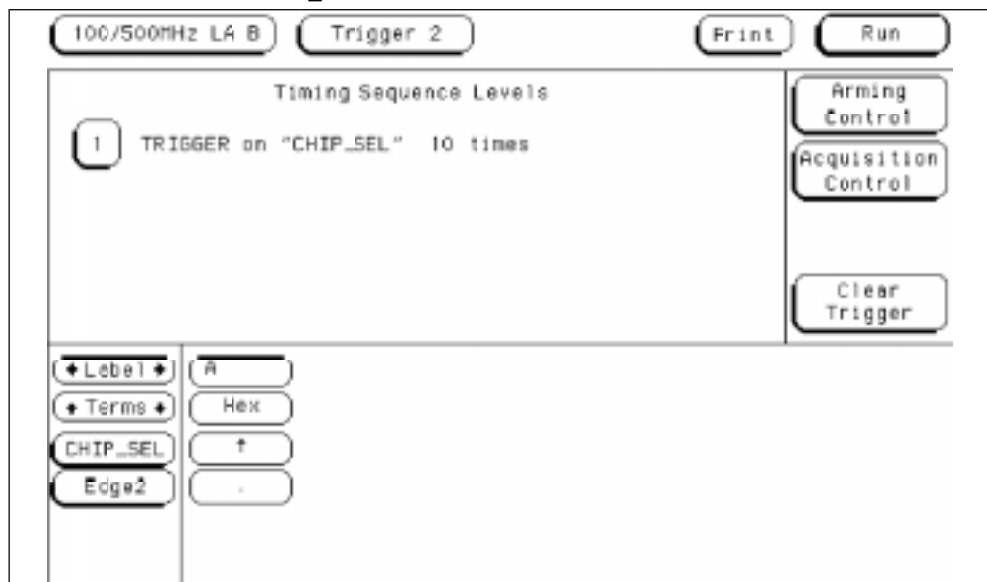

Triggering on the 10th Assertion of a Chip Select Line

on the address bus is stable

To verify that the chip select line of a memory chip is strobed after the address on the address bus is stable

- 1 Select the timing analyzer Trigger menu.
- 2 Define a term called ADDRESS to represent the address in question and the Edge1 term to represent the asserting transition on the chip select line.

You can rename the Edge1 term to suit the problem, for example, to MEM\_SEL.

- 3 Under Timing Sequence Levels, enter the following sequence specification:

- Find "ADDRESS" > 80 ns
- TRIGGER on "MEM\_SEL" 1 time Else on "≠ ADDRESS" go to level 1

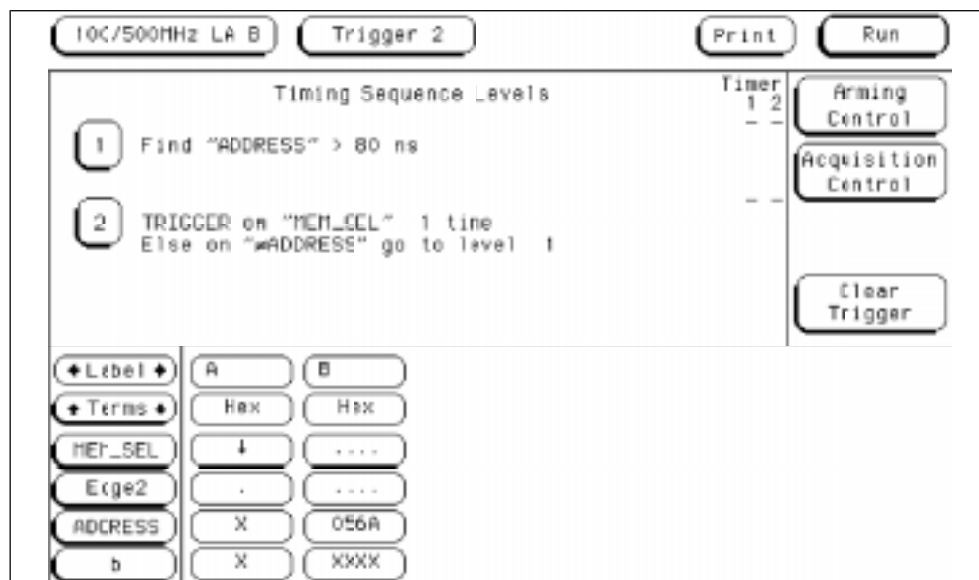

Verifying Setup Time for Memory Address

---

## To trigger when expected data does not appear on the data bus from a remote device when requested

- 1 Select the timing analyzer Trigger menu.
- 2 Define a term called DATA to represent the expected data, the Edge1 term to represent the chip select line of the remote device, and the Timer1 term to identify the time limit for receiving expected data.  
You can rename the Edge1 and Timer1 terms to match the problem domain, for example, to REM\_SEL and ACK\_TIME.
- 3 Under Timing Sequence Levels, enter the following sequence specification:

- Find “REM\_SEL” 1 time
- TRIGGER on “ACK\_TIME > 16.00  $\mu$ s” 1 time Else on “DATA” go to level 1

You will need to use the Timer Control field in the sequence setup for sequence level 2 to start the ACK\_TIME timer upon entering that sequence level.

This sequence specification causes the analyzer to trigger when the data does not occur in 16  $\mu$ s or less. If it does occur within 16  $\mu$ s, the sequence restarts. Specifications of this type are useful in finding intermittent problems. You can set up and run the trace, then cycle the system through temperature and voltage variations, using automatic equipment if necessary. The failure will be captured and saved for later review.

device when requested

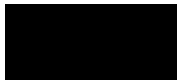

10C/500MHz LA B    Trigger 2    Print    Run

Timing Sequence Levels		Timer	
		1	2
1	Find "REN_SEL" 1 time	-	-
2	TRIGGER on "ACK_TIME > 16.00us" 1 time Else on "DATA" go to level 1	-	-

Arming Control  
Acquisition Control  
Clear Trigger

+Label +  
+Terms +  
ACK\_TIME    16.00 us  
Timer2    400 ns

Triggering When I/O Data Not Returned

---

## To test minimum and maximum pulse limits

- 1 Select the timing analyzer Trigger menu.
- 2 Define the Edge1 term to represent the positive-going transition, and define the Edge2 term to represent the negative-going transition on the line with the pulse to be tested.

You can rename these terms to POS\_EDGE and NEG\_EDGE.

- 3 Define the Timer1 term to represent the minimum pulse width, and the Timer2 term to represent the maximum pulse width.

You can rename these terms to MIN\_WID and MAX\_WID. In this example, Timer1 was set to 496 ns and Timer2 was set to 1  $\mu$ s. Both timers start when sequence level 2 is active.

- 4 Under Timing Sequence Levels, enter the following sequence specification:

- Find “POS\_EDGE” 1 time
- Then find “NEG\_EDGE” 1 time
- TRIGGER on “MIN\_WID 496 ns + MAX\_WID 1.00  $\mu$ s” 1 time Else on “anystate” go to level 1

Because both timers start when entering sequence level 2, they start as soon as the positive edge of the pulse occurs. Once the negative edge occurs, the sequencer transitions to level 3. If at that point, the MIN\_WID timer is less than 496 ns or the MAX\_WID timer is greater than 1  $\mu$ s, the pulse width has been violated and the analyzer should trigger. Otherwise, the sequence is restarted.

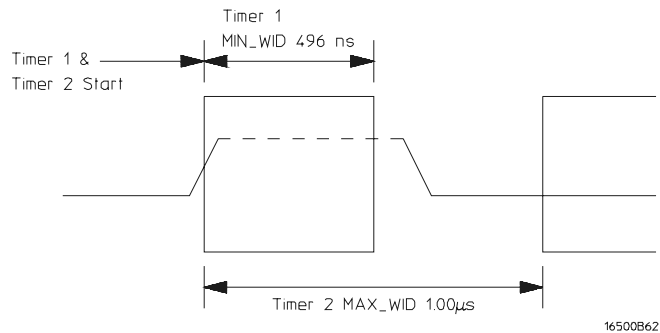

Measurement of Minimum and Maximum Pulse Width Limits



100/500MHz LA B		Trigger 2		Print	Run
Timing Sequence Levels				Timer	Arming Control
1	Find "POS_EDGE" 1 time	1	-	S S	
2	Then find "NEG_EDGE" 1 time	2	-		
3	TRIGGER on "MIN_HID<496ns+MAX_HID..." 1 time Else on "anystate" go to level 1				Clear Trigger
Label	A	B			
Terms	Hex	Hex			
POS_EDGE	↑	....			
NEG_EDGE	↓	....			
a	X	XXXX			
b	X	XXXX			

Triggering when a Pulse Exceeds Minimum or Maximum Limits

---

## To detect a handshake violation

- 1 Select the timing analyzer Trigger menu.
- 2 Define the Edge1 term to represent either transition on the first handshake line, and the Edge2 term to represent either transition on the second handshake line.  
You can rename these terms to match your problem, for example, to REQ and ACK.
- 3 Under Timing Sequence Levels, enter the following sequence specification:
  - Find “REQ” 1 time

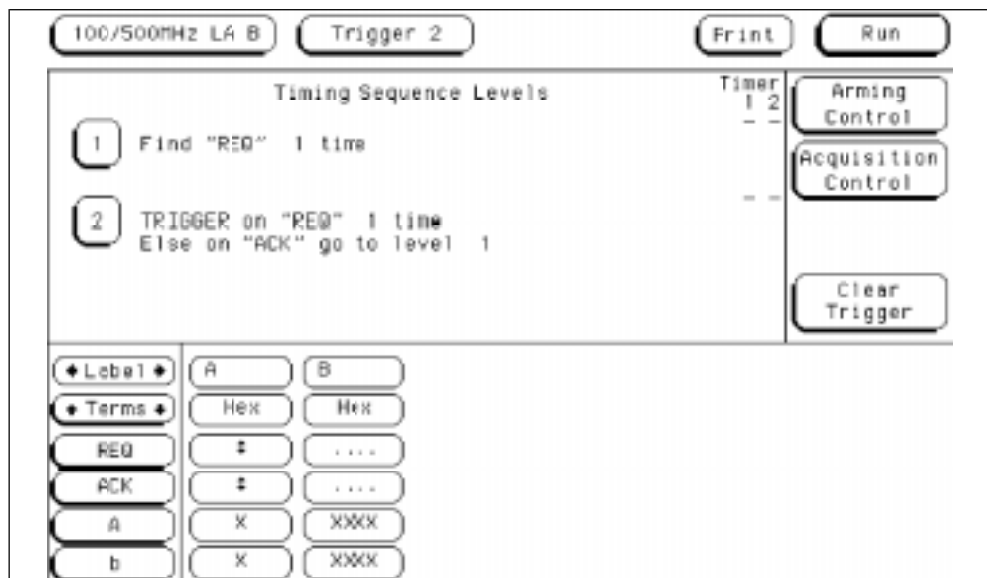

- TRIGGER on “REQ” 1 time Else on “ACK” go to level 1

### Triggering on a Handshake Violation





---

## To detect bus contention

In this sequencer setup, the trigger occurs only if both devices assert their bus transfer acknowledge lines at the same time.

- 1 Select the timing analyzer Trigger menu.
- 2 Define the Edge1 term to represent assertion of the bus transfer acknowledge line of one device, and Edge2 term to represent assertion of the bus transfer acknowledge line of the other device.

You can rename these to BTACK1 and BTACK2.

- 3 Under Timing Sequence Levels, enter the following sequence specification:

TRIGGER on "BTACK1 • BTACK2" 1 time

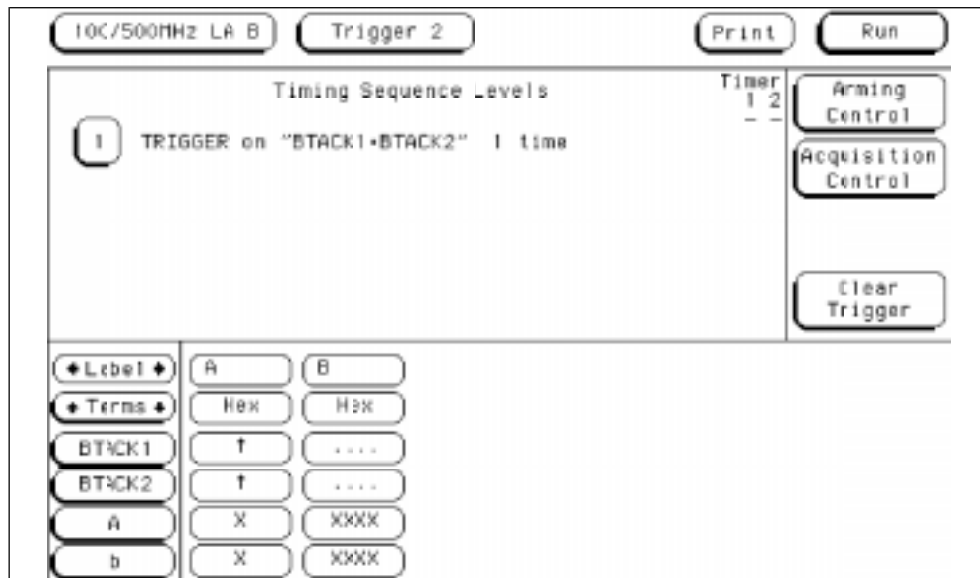

Triggering on Bus Contention

---

## Cross-Arming Trigger Examples

The following examples use cross arming to coordinate measurements between two instruments. The cross-arming is set up in the Arming Control menu (obtained by selecting Arming Control in the Trigger menu). When coordinating measurements between two or more analyzers, select Count Time so you can correlate the measurements made by the two analyzers.

**See Also**

Chapter 2, “Intermodule Measurements.”



---

## To examine software execution when a timing violation occurs

The timing analyzer triggers when the timing violation occurs, and when it triggers, it also sets its “arm” level to true. When the state analyzer receives the arm signal, it triggers immediately on the present state.

- 1** Select the timing analyzer Trigger menu.
- 2** Define the Edge1 term to represent the control line where the timing violation occurs.
- 3** Under Timing Sequence Levels, enter the following sequence specification:  
TRIGGER on “glitch/edge1” 1 time
- 4** Select the state analyzer Trigger menu and accept the default (anystate) definition for term a.
- 5** Under State Sequence Levels, enter the following sequence specification:
  - While storing “anystate” TRIGGER on “arm • a” 1 time
  - Store “anystate”

---

## To look at control and status signals during execution of a routine

The state analyzer will trigger on the start of the routine whose control and status signals are to be examined with finer resolution than once per bus cycle. When it triggers, it will switch its “arm” level true. The timing analyzer will trigger when it receives the true arm level and detects the transition represented by glitch/edge1.

- 1** Select the state analyzer Trigger menu and define term R\_START to represent the starting address of the routine.
- 2** Under State Sequence Levels, enter the following sequence specification:
  - While storing “anystate” TRIGGER on “R\_START” 1 time
  - Store “anystate”
- 3** Select the timing analyzer Trigger menu.
- 4** Define the Edge1 term to represent a transition on one of the control signals.
- 5** Under Timing Sequence Levels, enter the following sequence specification:
  - TRIGGER on “arm • Edge1” 1 time



## Intermodule Measurements

---

## Intermodule Measurements

An intermodule measurement is a measurement that is coordinated between two or more modules to capture different types of information related to a problem you are trying to solve. This chapter shows you how to make several kinds of intermodule measurements.

Intermodule measurements can involve state analyzers, timing analyzers, oscilloscopes, and pattern generators. The measurement may be as simple as coordinating the startup of several modules during a measurement; it may be quite complex and include multiple arming sequences between modules and external equipment.

For example, you may have a timing analyzer detect the occurrence of a glitch, and at the same time, have an oscilloscope capture the glitch waveform and a state analyzer capture the program flow before and after the occurrence of the glitch. With several types of information obtained from various analysis modules, you can discover problems that would otherwise be difficult to identify.

The figure on the opposite page shows how intermodule bus arming signals are connected between modules inside the HP 16500B and HP 16501A. Note that any arm input can be driven by any slot, and that the port input line can drive any slot.

If you are unfamiliar with the basic operation of the Intermodule Menu, try working the examples in the *Logic Analyzer Training Kit*.

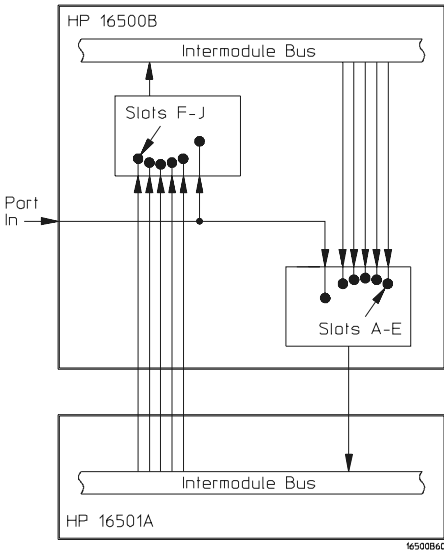
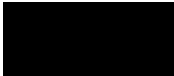

Intermodule Bus Block Functional Diagram

---

## Intermodule Measurement Examples



To set up an intermodule measurement, you must use the Intermodule menu. All modules that will participate in the intermodule measurement must be represented in this menu and their relationships must be shown under the Group Run field.



---

## To set up a group run of modules within the HP 16500B

Modules are armed in the configuration tree by either an individual module or the Group Run field. When armed, a module begins searching for the input that will satisfy its trigger specification. To obtain a specification that triggers on the arm signal, specify to trigger on “anystate.”

- 1** Select the Intermodule menu.
- 2** Select the second field down from the top on the left, then select Group Run.
- 3** Select the name of each module you want to include in the measurement.

The modules are listed under “Modules” on the right side of the menu.

- a** Select Group Run if you want to arm this module immediately when the Group Run begins.
  - b** Select the name of another module if you want the other module to arm the present one when the other module finds its trigger.
  - c** Select Independent if this module should not be included in the intermodule measurement.
- 4** Select the Group Run field in the upper right hand corner.

The group run begins. The modules attached directly to the Group Run field immediately begin searching for their respective trigger conditions. When a module finds its trigger, it arms any modules attached to it in the Group Run tree.

Intermodule Measurements  
To set up a group run of modules within the HP 16500B



The analyzer in slot B is armed when the oscilloscope in slot D finds its trigger condition.

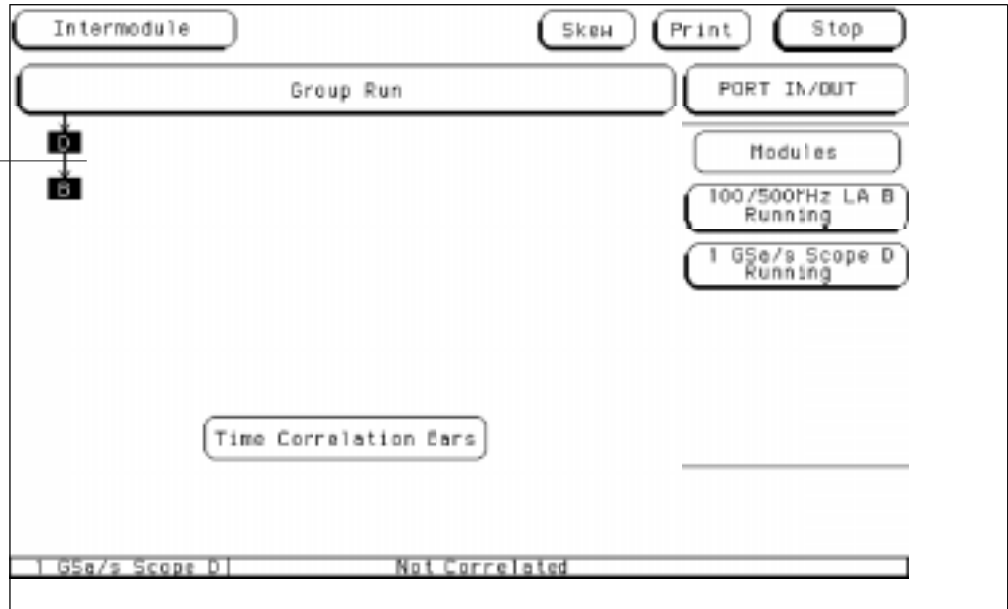

Oscilloscope Arms State Analyzer in Group Run

---

## To start a group run of modules from an external trigger source

- 1** Connect the arm signal from the external instrument or system to the PORT IN BNC connector on the rear panel of the HP 16500 frame.
- 2** Select the Intermodule menu.
- 3** Set up the group run specification.
- 4** Select the PORT IN/OUT field.
  - a** Select the field under PORT IN Level, then select the level that matches the external signal that will be applied to the PORT IN BNC on the HP 16500B rear panel.
- 5** Select the Group Run field in the upper right hand corner.

The choices are TTL, ECL, and User. The latter allows you to specify a voltage from  $-4.00$  V to  $+5.00$  V using an onscreen keypad.

- b** Select the field under PORT IN Edge to change from Rising to Falling edge and vice-versa for the rear-panel input signal.
- c** Select Done to leave the PORT IN/OUT Setup menu.

The modules attached directly to the Group Run Armed from PORT IN field wait for a signal from the PORT IN field.

- 6** Start the external instrument or system.

When the external instrument sends the proper signal to the PORT IN BNC, the internal modules attached directly to the Group Run Armed from PORT IN field are armed and begin searching for their respective trigger conditions.

Modules are armed by modules above them, either an individual module or the field named Group Run Armed from PORT IN. That is, in the intermodule display, an arrow pointing to a module to be armed originates in the module providing the arm signal. See the figure "Oscilloscope Arms State Analyzer in Group Run" on page 2-6. When armed, a module begins searching for the input that will satisfy its trigger specification. To obtain a specification of "trigger on the arm signal," specify a trigger that equates to "trigger on anything."

### See Also

"To set up a group run of modules within the HP 16500B."



Both the analyzer in slot B and the oscilloscope in slot D are armed when the PORT IN signal arrives.

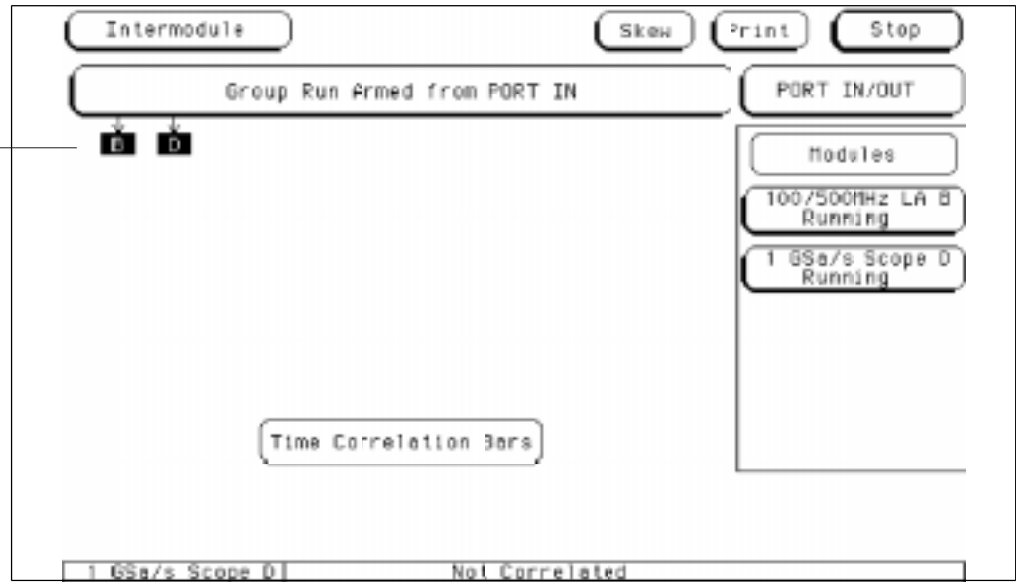

State Analyzer and Oscilloscope armed from PORT IN

**See Also**

“To set up a group run of modules within the HP 16500B” in this chapter.

---

## To start an external instrument on command from a module within the HP 16500 and 16501 mainframe

You can set up a module in a group run so that it sends a pulse through the PORT OUT rear panel BNC. The pulse can be used to start or stop a measurement in an external instrument or system.

**1 Set up the group run specification.**

See “To start a group run of modules within the HP 16500B” or “To start a group run of modules from an external trigger source.”

**2 Select PORT IN/OUT.**

The PORT IN/OUT Setup menu appears.

**3 Select the PORT OUT field.**

- Select Off if no module should drive PORT OUT.

or

- Select the name of the module you want to have drive PORT OUT.

**4 Select Done in the PORT IN/OUT Setup menu.**

The output from the PORT OUT BNC is an active high TTL level.

**See Also**

“To set up a group run of modules within the HP 16500B” or “To start a group run of modules from an external trigger source” in this chapter.

## Intermodule Measurements

To start an external instrument on command from a module within the HP 16500 and 16501 mainframe



The analyzer in slot B drives port out after finding its trigger.

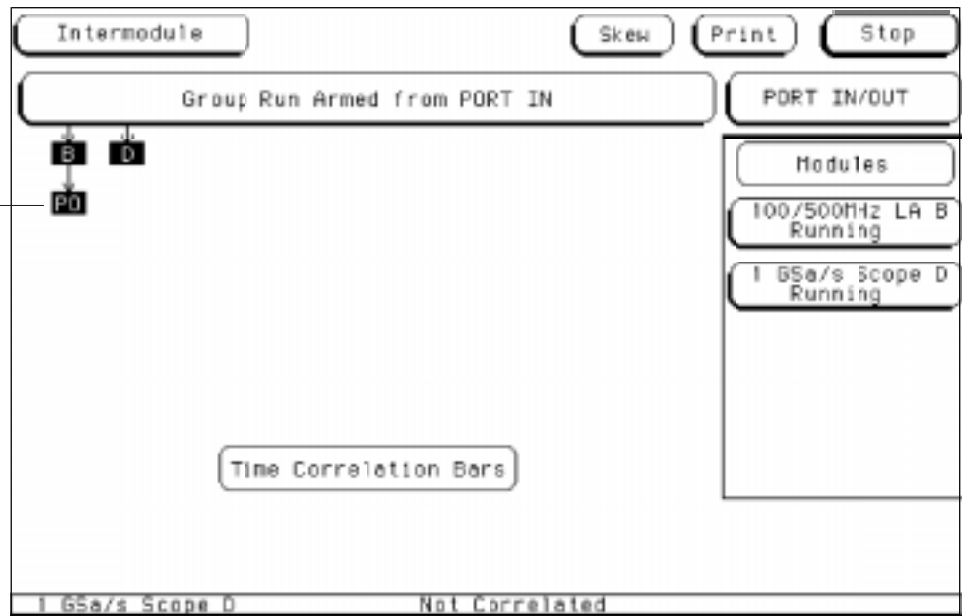

Driving the Port Out BNC in an Intermodule Measurement

---

## To see the status of a module within an intermodule measurement

- 1 Select the Intermodule menu.
- 2 Find the name of the module under the “Modules” list, and read the status under the module name.

The status can be either Running or Stopped. You can interpret these indications as follows:

- If a module was running and is now stopped, assume it received its arming signal, triggered, and finished its measurement properly.
- If a module located below a stopped module on the intermodule configuration tree has received an arming signal and is still running, either it is still waiting to satisfy its trigger specification or it has not captured enough information to fill its memory.
- If a module below a running module on the intermodule configuration tree has not received its arming signal, it will not begin running until the upper module finds its trigger condition.

Both modules are running because neither has found its respective trigger condition.

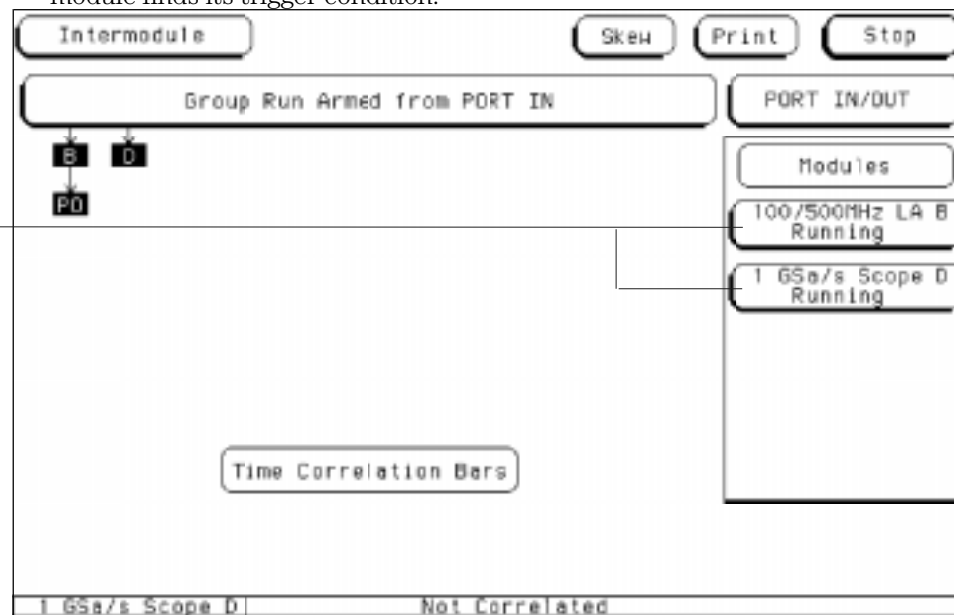

Module Status

## To see time correlation of each module within an intermodule measurement

Time correlation in the intermodule menu can help you see when the trigger occurred for each module and the relative time range of data captured by that module.

- 1 Select Time in the Count field of the trigger menu of each logic state analyzer whose measurement will be time-correlated with the other modules.

Timing analyzers and digitizing oscilloscopes implicitly count time because their sampling is driven by an internal clock, rather than an external state clock. See the *User's Reference* for your logic state analyzer for details on how to count time with the analyzer.

- 2 Select the Intermodule menu.
- 3 Select the Group Run field in the upper right hand corner.

Once the measurement has started, view the time correlation bars at the bottom of the Intermodule Menu. The "T" in each bar indicates the relative time at which that module found its trigger condition. The yellow portion of each bar indicates the start and stop points of the acquisition window of the associated module relative to the other modules in the measurement.

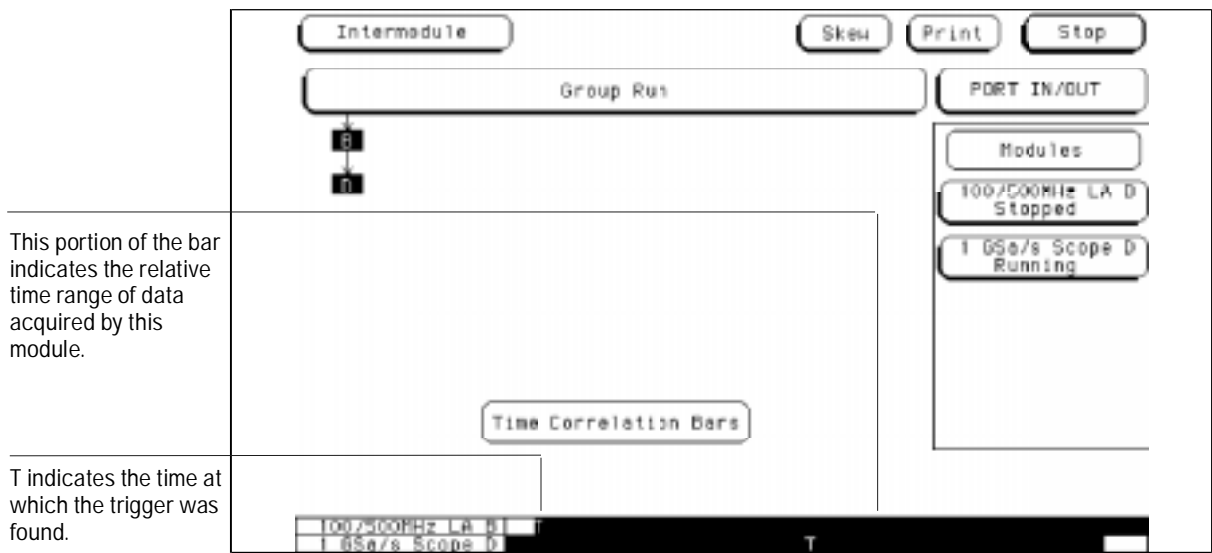



---

## To use a timing analyzer to detect a glitch

The following setup uses a state analyzer to capture state flow occurring at the time of the glitch. This can be useful in troubleshooting. For example, you might find that the glitch is ground bounce caused by a number of simultaneous signal transitions.

- 1 Select the Intermodule menu.**
- 2 Select the timing analyzer from the Modules list and set it to Group Run. Select the state analyzer and set it to respond to the arm signal from the timing analyzer.**

You must have fully independent state and timing analyzers to make this type of measurement. For example, though the HP 16550A can be configured to use some of its channels for a state analyzer and some for a timing analyzer, it cannot present those analyzers independently for intermodule measurements.

- 3 Select the timing analyzer Trigger menu.**
- 4 Select an Edge term. Then assign glitch detection "\*" to the channels of interest represented by the Edge term.**
- 5 Select the state analyzer Trigger menu.**
- 6 Set the analyzer to trigger on any state and store any state.**
- 7 Select Group Run in the upper right corner of the display.**

If you don't see the activity of interest in the state trace, try changing the trigger position using the Acquisition Control field in the Trigger menu of the state analyzer. By changing the Acquisition mode to manual, you can position the trigger at any state relative to analyzer memory.

The timing analyzer can detect glitch activity on a waveform. A glitch is defined as two or more transitions across the logic threshold between adjacent timing analyzer samples.

## To capture the waveform of a glitch

The following setup uses the triggering capability of the timing analyzer and the acquisition capability of the oscilloscope.

- 1** Select the Intermodule Menu.
- 2** Select the timing analyzer from the Modules list and set it to Group Run. Select the oscilloscope module and set it to respond to the arm signal from the timing analyzer.
- 3** Select the timing analyzer module.
- 4** Select the Trigger menu, and within the menu, select an Edge term.
- 5** Assign glitch detection "\*" to the channel of interest represented by the Edge term.

This will usually be the same channel monitored by the oscilloscope.

- 6** Select the oscilloscope Trigger menu, and set Mode to Immediate.
- 7** Select the Group Run field in the upper right corner.

If you have trouble capturing the glitch waveform on the oscilloscope, try adjusting the skew in the Intermodule menu, so the oscilloscope triggers earlier.

A timing analyzer can trigger on a glitch and capture it, but a timing analyzer doesn't have the voltage or timing resolution to display the glitch in detail. An oscilloscope can display a glitch waveform with fine resolution, but cannot trigger on glitches, combinations of glitches, or sophisticated patterns involving many channels.

---

## To capture state flow showing how your target system processes an interrupt

Use an oscilloscope with a sample rate faster than the microprocessor clock rate to trigger on the asynchronous interrupt request.

- 1 Select the Intermodule menu.
- 2 Select the oscilloscope from the Modules list and set it to Group Run. Select the state analyzer module and set it to respond to the arm signal from the oscilloscope module.
- 3 Select the oscilloscope module.
- 4 Select the Trigger menu, and set the mode to Edge trigger.
- 5 Select the state analyzer module.
- 6 Select the Trigger menu of the state analyzer, and set the analyzer to trigger on any state and store any state.
- 7 Select Group Run from the upper right corner of the display.

When the interrupt occurs, the oscilloscope will trigger, subsequently triggering the state analyzer.

If the analyzer doesn't capture the expected interrupt activity, ensure that the interrupt isn't masked due to the actions of other program code.

This setup can help you answer questions like the following:

- Does the processor branch to the proper interrupt handling routine?
- Are registers and status information saved properly?
- How long does it take to service the interrupt?
- Is the interrupt acknowledged properly?
- After the interrupt is serviced, does the processor restore registers and status information and continue with the interrupted routine as expected?

You can use the state analyzer to check the address of the interrupt routine as well as to see if interrupt processing is done as expected. Using a preprocessor and inverse assembler with the state analyzer will make it easier to read the program flow.

## Intermodule Measurements

To capture state flow showing how your target system processes an interrupt

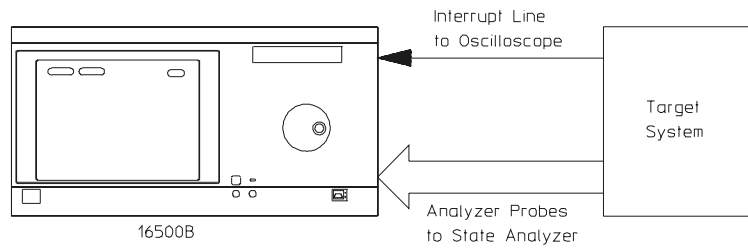

### Interrupt Capture Setup

16500E77

---

## Using stimulus-response to test a circuit

- 1** Select the Intermodule menu.
- 2** Select the pattern generator from the Modules list and set it to Group Run. Select the oscilloscope module and set it to respond to the arm signal from the pattern generator. Select the state analyzer and set it to respond to the arm signal from the pattern generator.
- 3** Load the pattern generator with the proper patterns to simulate the signals from the driving hardware.
- 4** Insert the “Signal IMB” instruction at the desired point in the pattern generator program.  
The arm signal is programmable. It can occur anywhere in the pattern generator cycle.
- 5** Select the oscilloscope Trigger Menu. Set the oscilloscope to trigger on signals of interest in the circuit under test.
- 6** Select the state analyzer Trigger Menu. Set the analyzer to trigger on addresses, data, or status conditions of interest, and to store any state or states of interest.
- 7** Select Group Run from the upper right corner of the display.  
The pattern generator will begin its cycle, and will arm the oscilloscope and state analyzer.

In the early stages of system design and integration, you may want to test a circuit when the driving hardware that will stimulate it has not yet been designed or fabricated. You can also use the pattern generators with the logic analyzer to test PC boards when no board-test system is available.

The HP 16520A and HP 16521A pattern generators for the HP 16500B avoid the inconvenience of having to stack several signal generators on top of each other, with all of the cable connections required for those signal generators. Additionally, you have a single interface to access all the test modules in your measurement.

Intermodule Measurements  
Using stimulus-response to test a circuit

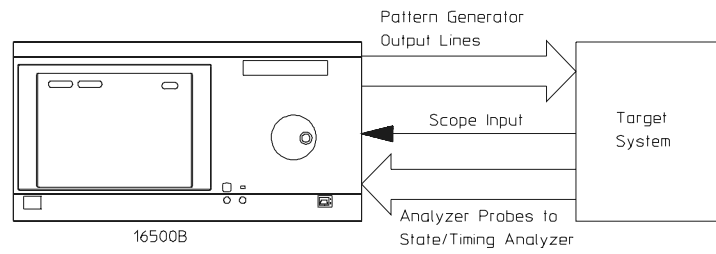

**Stimulus-Response Setup**

**See Also**

The *HP 16520A User's Reference* for the procedures for operating the pattern generator.

data lines

---

## To use a state analyzer to trigger timing analysis of a count-down on a set of data lines

- 1 Select the Intermodule menu.
- 2 Select the state analyzer from the Modules list and set it to Group Run. Select the timing analyzer and set it to respond to the arm signal from the state analyzer.
- 3 Select the state analyzer Trigger menu.
- 4 Set the state analyzer to trigger on the label and term that identify the start of the count-down routine.  
If you are not familiar with the procedures for setting up a trigger condition, see chapter 1.
- 5 In the timing analyzer Trigger Menu, set the timing analyzer to trigger on any state and store any state.
- 6 Select Group Run from the upper right corner of the display.

Your target system may include various state machines that are started by system events: interrupt processing, I/O activity, and the like. The state analyzer is ideal for recognizing the system events; the timing analyzer is ideal for examining the step-by-step operation of the state machines.

---



## To use two state analyzers to monitor the activity of coprocessors in a target system

- 1 Select the Intermodule menu.
- 2 Select the first state analyzer from the Modules list and set it to Group Run. Select the second state analyzer and set it to respond to the arm signal from the first analyzer.
- 3 Select the Trigger menu of the first analyzer.
- 4 Set the first analyzer to trigger on the problem condition.  
Some problems may involve complex sequences of conditions. See chapter 1, “Triggering,” for more information on defining a trigger sequence.
- 5 Select the Trigger menu of the second analyzer.
- 6 Set the second analyzer to trigger on any state and store any state.
- 7 Select Group Run from the upper right corner of the display.

After the measurement is complete, you can interleave the trace lists of both state analyzers to see the activity executed by both coprocessors during related clock cycles.

You can use a similar procedure if you have only one processor, but wish to monitor its activity with that of other system nodes, such as chip-select lines, I/O activity, or behavior of a watchdog timer. In some instances it may be easier to look at related activity with a timing analyzer.

### See Also

“Special Displays” in this chapter.

“To use a state analyzer to trigger timing analysis of a count-down on a set of data lines” in this chapter.

Debugging coprocessor systems can be a complex task. Replicated systems and contention for shared resources increase the potential problems. Using two state analyzers with preprocessors can make it much easier to discover the source of such problems. For example, you may wish to set up one analyzer to trigger only when a certain problem occurs, and set up the other analyzer to be armed by the first analyzer so that it takes its trace only when the first analyzer recognizes its trigger. This will let you observe the behavior of both coprocessors during the occurrence of a problem.





### **Interleaved Trace Lists**

Interleaved trace lists allow you to view data captured by two or more analyzers in a single trace list. When you interleave the traces, you see each state that was captured by each analyzer. These states are shown on consecutive lines.

You can interleave state listings from HP 16510B, 16540A, 16540D, and 16550A state analyzers, when two or more are used together in a group run. Interleaved state listings are useful when you are using multiple analyzers to look at interaction between two or more processors. They are also useful when you need more analysis width than is available in one analyzer.

### **Mixed Display Mode**

The Mixed Display mode allows you to show state listings and waveforms together on screen, if all were obtained by modules within the HP 16500B and 16501A frame. State listings are shown at the top of the screen and waveform displays are shown at the bottom. You can interleave state listings from two analyzers at the top of the screen, if desired. You can display waveforms from two oscilloscopes or timing analyzers at the bottom of the screen.

---

## To interleave trace lists

- 1 Set up the analyzers whose data you wish to interleave as part of a group run.**

You won't need to do this if the two measurement modules for which you want mixed display are really part of the same module. For example, you might have an HP 16550A state/timing analyzer configured as two separate analyzers, one a state analyzer, the other a timing analyzer. You can use mixed display to view the timing analyzer waveform with the trace lists from the state analyzer.

- 2 Select the first state analyzer whose trace list will be shown in the interleaved display.**

- 3 Select Trigger from the menu field and set Count to Time.**

The system uses the time stamps stored with each state to determine the ordering of states shown in an interleaved trace list.

- 4 Repeat steps 2 and 3 for the second state analyzer.**

- 5 Select Listing Display from the Menu field.**

- 6 Select one of the label fields in the trace list display, then select Interleave.**

- 7 Select the name of the analyzer whose trace list will be interleaved with the first analyzer. Then choose the label that you want to interleave from the selected analyzer.**

Interleaved data is displayed in yellow. Trace list line numbers of interleaved data are indented. The labels identifying the interleaved data are shown above the labels for the current analyzer, and are displayed in yellow.

If you have problems with the procedure, and you are using two independent analyzers, first ensure that the analyzers are set up as part of a group run. Ensure that each analyzer is set to Count Time and that each analyzer has an independent clock from the target system.

You can interleave trace lists from state analyzers that were configured as part of a group run or from state analyzers that are configured as separate analyzers within the same measurement module. In the first case, you might have two HP 16550A analyzers configured in a group run; in the second, you might have a single HP 16550A configured as two state analyzers. The interleaved trace lists are shown as a time-correlated, state-to-state display.

Labels for the interleaved states are shown above those for the primary analyzer.

Interleaved states are shown in yellow with line numbers indented from those of the primary analyzer.

The screenshot shows the HP 16550A interface with several control buttons at the top: '100/500MHz LA B', 'Listing 1', 'Invasn', 'Print', and 'Stop'. Below these are 'Markers Off' and 'Acquisition Time 17 Nov 1993 12:39:04'. A control panel includes 'Label>' and 'Base>' buttons, and fields for 'A', 'ADDR', 'CPU32 Mnemonic', 'STAT', 'Hex', 'hex', and 'Symbol'. The main display shows a list of states with line numbers 0-9. Line 0 is highlighted in yellow and contains the text '4099A ORI.B #2F,04 Opcode Fetch'. Line 9 is also highlighted in yellow and contains '4099C 022F pgn read Opcode Fetch'. Other lines (1-8) show '0' in the address field and '0' in the mnemonic field.

Interleaved Trace Lists on the HP 16550A

**See Also** "To set up a group run of modules within the HP 16500B" in this chapter.

---

## To view trace lists and waveforms together on the same display

- 1 Set up the modules whose data you wish to view as part of a group run.**

You won't need to do this if the two measurement modules for which you want mixed display are really part of the same module. For example, you might have an HP 16550A state/timing analyzer configured as two separate analyzers, one a state analyzer, the other a timing analyzer. You can use mixed display to view the timing analyzer waveform with the trace lists from the state analyzer.

- 2 Select the module for which you wish to show waveforms.**

This might be an oscilloscope module or a timing analyzer.

- 3 Select the label field to the left of the waveform display area twice, then choose the waveforms to be shown.**

When you double-select the label field to the left of the waveform display area, a new menu appears that allows you to insert and delete signals and choose the relative display size and position for the signals.

- 4 Select the state analyzer.**

- 5 Set the Trigger menu of the state analyzer and set the Count field to Time.**

Timing analyzers and digitizing oscilloscopes implicitly count time because their sampling is driven by an internal clock, rather than an external state clock. See the manual for your logic state analyzer for details on how to count time with the analyzer.

- 6 To insert state listings, select any label field from the state listing. From the popup that appears, select the desired label to insert.**

- 7 Select Mixed Display from the menu field.**

- 8 Select Group Run from the upper right corner of the display.**

You can position X and O Time markers on the waveform display, if desired. Once set, the time markers will be displayed in both the listing and the waveform display areas. Note that even if you set X and O Time markers in another display, you must also set the Time markers in the Mixed Display if Time markers are desired.

You can use the Mixed Display feature in the state analyzer menus to show both waveforms and trace lists in the same display, making it easier to correlate the events of interest.

If you are using mixed display as part of a group run, you may need to adjust intermodule skew to ensure proper time correlation and display results.

**Mixed Display using the HP 16550A and HP 16532A**

**See Also**

X and O markers from the waveform display are shown in their relative position on the state display.

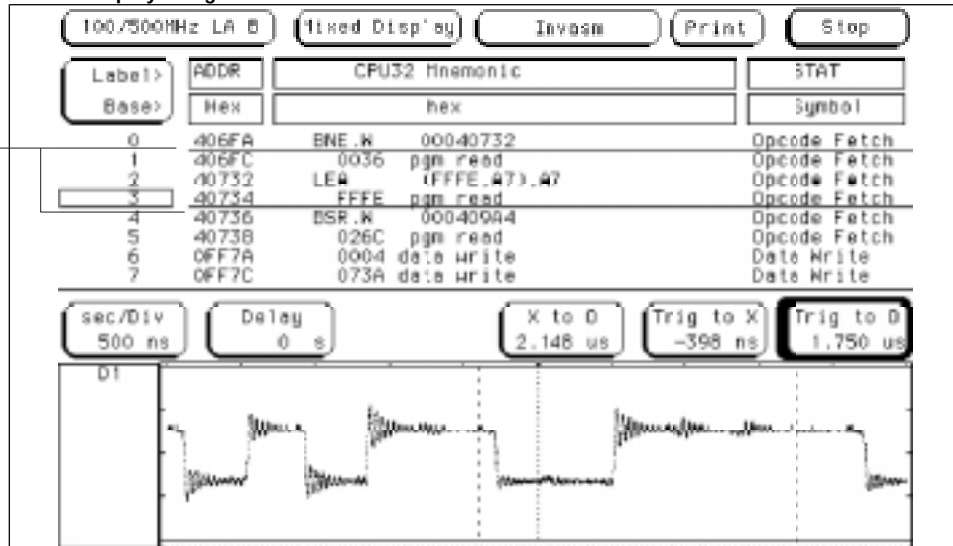

“To set up a group run of modules within the HP 16500B” in this chapter.  
 “Skew Adjustment” in this chapter.

---

## Skew Adjustment



You can modify the skew or timing deviation between modules within the intermodule measurement. This allows you to compensate for any known delay of the system under test, or to compare two signals by first removing any displayed skew between the signal channels.

Skew adjustments can correct module delays to within 2 ns of other modules. Note that the module or channel that is used as the trigger is normally the reference channel, and adjustments are normally made to deskew the nonreference channels.

---

## To adjust for minimum skew between two modules involved in an intermodule measurement

### 1 Connect an input signal from each module to the same signal.

An ideal signal for testing skew is a single-shot signal with fast risetime. Such a signal simplifies triggering and makes it easier to correlate the input event between the modules. Ensure that you use proper probe grounding for maximum signal fidelity.

### 2 Select the Intermodule menu.

### 3 Set up both modules so they will begin searching for the trigger immediately when a group run begins.

This setup focuses mostly on trying to eliminate probe skew and internal triggering delays. You can use other intermodule setups as well. For example, you may be interested in nullifying the effects of the internal arming delay in a setup where one module arms another.

### 4 Set up the trigger conditions for each module.

This will depend upon your input signal. For example, if you are adjusting intermodule skew using a single-shot pulse with a rising edge, set a timing analyzer to trigger on a rising edge using the Edge1 term, and the oscilloscope to trigger on a positive slope.

### 5 Select the Display or Waveform menu in one of the modules.

### 6 Set up the display so that both input waveforms are displayed simultaneously.

You do this by selecting the label field to the left of the display twice. The second selection brings up a new menu that allows you to insert or delete waveforms. You can delete all but the waveform of interest from the first module, then add the waveform of interest from the second module. Select Done when finished.

### 7 Select Group Run.

You may now need to trigger the signal of interest, if, for example, it is activated by a push button. You may need multiple events to capture good waveforms for both measurement modules. Remember that the oscilloscope captures far more accurate waveform data than the timing analyzer. Thus, if the waveforms do not match exactly, it may only be because the waveform edge did not meet the timing analyzer's setup and hold time specifications for a particular sampling period.

**To adjust for minimum skew between two modules involved in an intermodule measurement**



- Record the difference between waveform events shown by the two modules.

You can use the X and O markers to measure the differences in delays.

- Select the Intermodule Menu.

- Select Skew, then enter a skew correction value for one of the modules using the knob or the keyboard.

- Return to the module waveform display and recheck the skew adjustment.

You will need to repeat steps 7 through 11 as needed until the trigger events on the two waveforms match as closely as possible.

Before making an intermodule measurement, you should remove skew between the modules to ensure that a simultaneous arm signal to both modules results in captures of the same events around the trigger.

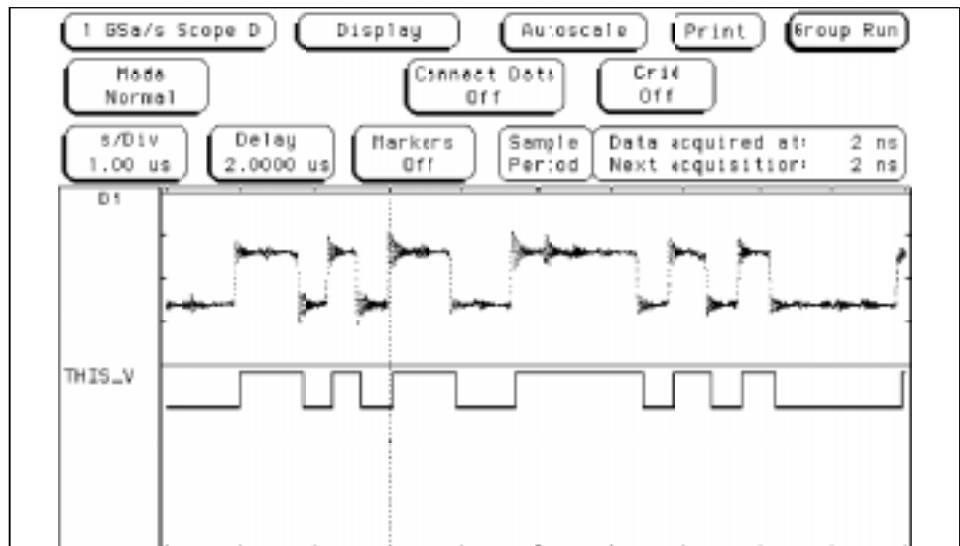

Skew Removal Between Timing Analyzer and Oscilloscope





## File Management

---

## File Management



A host computer such as a PC or UNIX workstation can enhance the HP 16500B in many ways. You can use the host to store configuration files or measurement results for later review. Screen images from the HP 16500B can be saved in bitmap files for inclusion in reports developed using word processors or desktop publishing tools. Or, you can develop programs on the PC that manipulate measurement results to satisfy your problem-solving needs.

This chapter shows you some examples of how to transfer files between a host computer and the HP 16500B, using the flexible disk drive and the optional HP 16500L LAN Interface. If you aren't familiar with basic flexible disk drive operations, see the *HP 16500B/16501A User's Reference*. If you need help setting up or understanding the use of the HP 16500L LAN Interface, see the *HP 16500L LAN Interface User's Guide*.

You can also use a host computer to send the HP 16500B complex command sequences—allowing you to automate your measurement tasks. If you want to program the HP 16500B using a host computer, see the *HP 16500B/16501A Logic Analysis System Programmer's Guide* and the *HP 16500L LAN User's Guide*.

---

## Transferring Files Using the Flexible Disk Drive

Because the flexible disk drive on the HP 16500B will read and write double-sided, double density or high-density disks in MS-DOS format, it is a useful tool for transferring images to and from IBM PC-compatible computers as well as other systems that can read and write MS-DOS format. You can save measurement configuration files, measurement results, and even menu and measurement images from the screen.

This section shows you how to use the flexible disk drive to:

- save a measurement configuration
- load a measurement configuration
- save a trace list in ASCII format
- save a screen image (such as an oscilloscope display or menu)
- load system software

If you need more information on the basic flexible disk drive operations, see the *HP 16500B/16501A Logic Analysis System User's Reference*.

---

## To save a measurement configuration

You can save measurement configurations on a 3.5" disk or on the internal hard disk for later use. This is especially useful for automating repetitive measurements for production testing.

- 1 Select System from the module field.
- 2 Select Hard Disk or Flexible Disk from the menu field.
- 3 Select Store from the disk operations field.
- 4 Select the module for which you want to save the configuration from the module list.

You can save the configuration for individual modules. The choice "System" saves only the mainframe configuration. The choice "All" saves the mainframe configuration and that of all measurement modules.

- 5 Specify a file name into which to save the configuration using the "to file" field.
- 6 Specify a descriptive comment for the file using the "file description" field.
- 7 Select Execute.

DOS Filename	Date	Time	Bytes	File Description
C68332	31Oct89	0:02:00	5632	68332EVS E2413A 16510/155x 2.0
Dsp_brok_B	31Oct89	0:02:00	27392	Display Broker 16550A config 2.0
ICPU32	31Oct89	0:02:00	13824	CPU32 Disassembler
LAB_10_B	31Oct89	0:02:00	27392	Initial Configuration
LAB_2_B	31Oct89	0:02:00	26880	Initial Configuration
START_B	31Oct89	0:02:00	27136	
START_C	31Oct89	0:02:00	2816	
START_D	31Oct89	0:02:00	68608	
START_	31Oct89	0:02:00	1280	

Saving the Oscilloscope Configuration for Skew Testing

If you want to save your file in a directory other than the root, you can select Change Directory from the disk operations field. Then type the name of the desired directory in the directory name field, or select it from the list of visible directories using the knob.



## To load a measurement configuration

You can quickly load a previously saved measurement configuration, saving the trouble of manually setting up the measurement parameters for each module.

- 1 Select System from the module field.**
- 2 Select Hard Disk or Flexible Disk from the Menu field.**  
Your choice here depends on where you saved the configuration.
- 3 Select Load from the disk operations field.**
- 4 Select the module for which you want to load a configuration from the module list.**

You can load configurations for individual modules. The choice "System" loads only the mainframe configuration. The choice "All" loads the mainframe configuration and that of all measurement modules.

However, you can only load configurations that are defined in the configuration file itself. Thus, if you select System, then select a file that contains only an analyzer configuration, the configuration will fail.

If you save an analyzer configuration as "All," then attempt to reload that configuration into a particular measurement module, configuration will fail. Also, configurations are slot dependent. If you save a configuration for a particular module, rearrange the modules within the HP 16500B, then try to reload the configuration, the configuration will not load.

- 5 Specify a file name from which to load the configuration using the "from file" field.**
- 6 Select Execute.**

System Flexible Disk Print

Load All from file START\_\_

file type: 16500A/B\_cnfg Execute

DOS Filename	Date	Time	Bytes	File Description	
ICPU32	31Oct89	0:02:00	13824	CPU32 Disassembler	2.0
LAB_10_B	31Oct89	0:02:00	27392	Initial Configuration	
LAB_2_B	31Oct89	0:02:00	26880	Initial Configuration	
START_B	31Oct89	0:02:00	27136		
START_C	31Oct89	0:02:00	2816		
START_D	31Oct89	0:02:00	68608		
START__	31Oct89	0:02:00	1280		

PKC: \

DOS Disk Space(bytes) - Total: 1474560 Free: -1

Loading Configuration for all HP 16500B Modules and the System

## To save a trace list in ASCII format

Some HP 16500B displays, such as file lists and trace lists, contain columns of ASCII data that you may want to move to a PC for further manipulation or analysis. You can save these displays as ASCII files, using a procedure similar to that for creating graphics images. While a graphics capture saves only the data shown onscreen, saving the display as an ASCII file captures all data in the list, even if it is offscreen.

- 1 Insert a DOS-formatted 3.5" disk in the flexible disk drive.**
- 2 Set up the menu you want to capture, or run a measurement from which you want to save data.**

Remember that only displays that present lists of textual data can be captured as ASCII files.

- 3 Select Print Disk from the Print menu.**
- 4 Select the Filename field and specify a file name to which the screen will be printed.**
- 5 Select ASCII (ALL) from the Output Format field.**  
If the current display contents can't be saved as an ASCII file, this option will not be present in the Output Format field.
- 6 Select Flexible Disk from the Output Disk menu.**
- 7 Select Execute.**



68332EVS - State Listing

Label	ADDR	CPU32 Mnemonic	STAT
0	406F4	ANDI.L #*****,(A6)+	Opcode Fetch
1	0FF7A	0004 data write	Data Write
2	0FF7C	06F6 data write	Data Write
3	40992	BSR.B 0004093E	Opcode Fetch
4	40994 nu	MOVE.B #*****,(****,A7)	Opcode Fetch
5	0FF76	0004 data write	Data Write
6	0FF78	0994 data write	Data Write
7	4093E	MOVE.W #03FF,00FFFA46	Opcode Fetch
8	40940	03FF pgm read	Opcode Fetch
9	40942	00FF pgm read	Opcode Fetch
10	40944	FA46 pgm read	Opcode Fetch
11	40946	MOVE.W #6B70,00FFFA72	Opcode Fetch
12	40948	6B70 pgm read	Opcode Fetch
13	4094A	00FF pgm read	Opcode Fetch
14	4094C	FA72 pgm read	Opcode Fetch
15	4094E	RTS	Opcode Fetch
16	40950 nu	MOVE.L D1,-(A7)	Opcode Fetch
17	0FF76	0004 data read	Data Read
18	0FF78	0994 data read	Data Read
19	40994	MOVE.B 00020001,(0004,A7)	Opcode Fetch
20	40996	0002 pgm read	Opcode Fetch
21	40998	0001 pgm read	Opcode Fetch
22	4099A	0004 pgm read	Opcode Fetch

Part of a Trace Listing Saved as an ASCII File

## To save a menu or measurement as a graphic image

You can save menus and measurements to disk in one of four different graphics formats.

- 1** Insert a DOS-formatted flexible disk in the flexible disk drive.
- 2** Set up the menu whose image you want to capture, or run a measurement from which you want to save data.
- 3** Select Print Disk from the Print menu.
- 4** Select the Filename field and specify a file name to which the screen will be printed.
- 5** Select the Output Format field and specify the output format for the graphics file.

Choose one of the following formats:

- B/W TIF (SCREEN) is a black and white Tagged Image File Format file in TIFF version 5.0 format
  - Color TIF (SCREEN) is a color TIFF file in TIFF version 5.0 format
  - PCX (SCREEN) is a color PCX file (PCX is the PC Paintbrush and Publisher's Paintbrush format from ZSoft)
  - EPS (SCREEN) is a black and white Encapsulated PostScript file
- 6** Select Flexible Disk from the Output Disk menu.
  - 7** Select Execute.

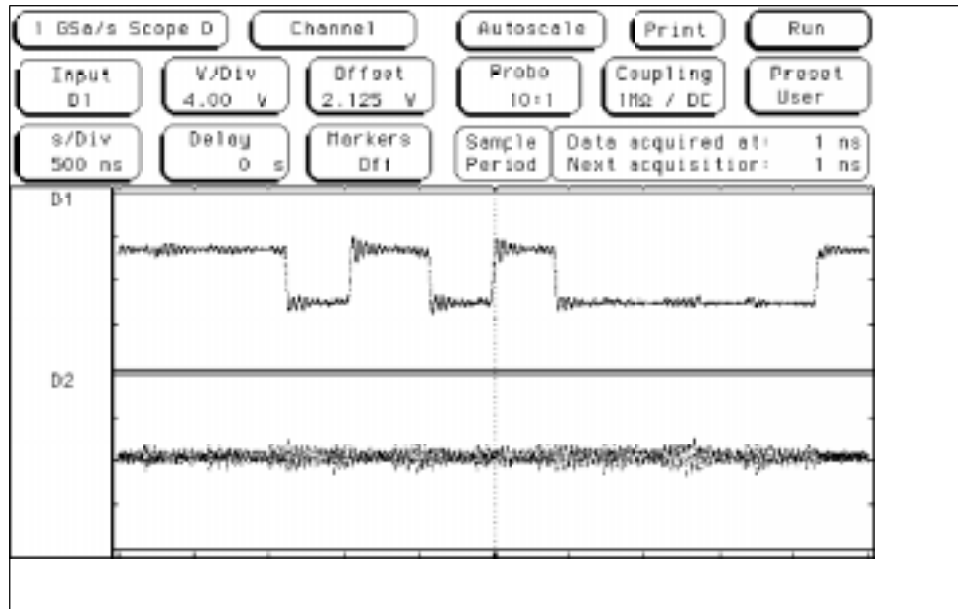

An Oscilloscope Display Saved as a TIF Image

## To load system software

- 1** Insert the first disk containing the system software.
- 2** Select System from the module field.
- 3** Select Hard Disk from the menu field.
- 4** Select Change Directory from the disk operation field.
- 5** Select the directory SYSTEM using the knob, and select Execute.
- 6** Select Flexible Disk from the menu field.
- 7** Select Copy from the disk operation field.
- 8** Select the file you want to update using the knob, then select Execute.

The selected file is copied to the \SYSTEM directory on the hard disk.

Repeat steps 7 and 8 for all files you need to update. If you have more than one disk from which you want to copy files, turn the knob after changing disks. This ensures that the HP 16500B will read the directory on the new disk.

---

## Using the HP 16500L LAN Interface

The HP 16500L LAN Interface option for the HP 16500B extends the Logic Analysis System by making it look like a NFS (Network File System) node. Using NFS utilities for the PC or NFS on a UNIX workstation, you can transfer files to and from the HP 16500B as if it were a disk drive attached to your machine. The LAN Interface also creates virtual directories and files for measurement configurations and measurement results, so you can store and retrieve these as though they were ordinary files.

This section shows you how to use the HP 16500L to do the following:

- set up the HP 16500B configuration
- retrieve measurement data from a module in the HP 16500B
- transfer images of HP 16500B menu and result screens to your host computer

If you have not connected your HP 16500B to the network, installed network software, or learned basic network commands, see the *HP 16500L User's Guide* and the *HP 16500L System Administrator's Guide* before performing the tasks in this chapter.

## To set up the HP 16500B

You can set up the HP 16500B from the front panel, or via the LAN. To set up the system via the LAN, you can use one of three methods:

- Copy a configuration file from your PC or workstation to one of the files called **setup.raw** in the HP 16500B directory tree.
- Remotely load a configuration file into the system from one of the local disk drives of the HP 16500B.
- Program the system directly, using the programming commands described in the *HP 16500B System Programmer's Guide*.

---

### Example

You want to load a configuration file called “486\_bus” from your local computer into an HP 16550A state/timing module. The HP 16550A is installed in slot B of the HP 16500B mainframe. The mainframe is mounted on your network as disk drive L: (assuming you are using a PC as the host).

To load the configuration file, enter the following at the DOS prompt:

```
C:\> copy 486_bus L:\slot_b\setup.raw
```

If you are using a UNIX system, you might use the **cp** command. In the Microsoft Windows environment, you can use the File Manager.

---

---

**Example**

You want to load a configuration file called “486\_bus” from the hard disk of the HP 16500B into an HP 16550A state/timing module. The HP 16550A is installed in slot B of the HP 16500B mainframe. To load the configuration file from the HP 16500B hard disk, you need to send the programming command to the analyzer. The syntax of the command is:

```
:MMEMory:LOAD:CONFig <filename>[,<disk drive>][,<slot number>]
```

In this case, the disk drive parameter, will be “INT0,” which indicates the hard disk. The slot number will be 2, because the HP 16550A is installed in slot B. To load the configuration file, enter the following command at the DOS prompt:

```
C:\> echo :MEM:LOAD:CON '486_BUS',INT0,2 L:\system\program
```

If you are using a UNIX system, you can use the UNIX **echo** command.

---

**See Also**

Chapter 4, “Programming the HP 16500B System via the LAN,” in the *HP 16500L User’s Guide*, for more information on programming the system directly.

The *HP 16500B System Programmer’s Guide* for more information on programming command syntax.

To copy files to the setup.raw file locations, or to send commands to the system at the \system\program file location, you must be connected to the HP 16500B system as the control user.

---

## To transfer data files from the HP 16500B system to your computer

You can transfer data from the HP 16500B system to your PC or workstation by copying files. Data files in binary format are available in file locations `\slot_x\data.raw`. These binary files can be transferred to your computer and then reloaded into the HP 16500B system later.

For some types of measurement modules, data files in ASCII format are also available. The ASCII data files are in file locations

```
\slot_x\data.asc\{analyzer name}\{label name}.txt
```

Depending on which measurement module you are using, there might not be a subdirectory corresponding to an analyzer name. There is an ASCII data file corresponding to each label name you have created in the measurement module.

**1 Set up the system for the measurement you want to make.**

You can do this from the front panel or remotely.

**2 Run the analyzer to acquire data.**

You can do this from the front panel or remotely.

**3 If you would like the data in binary format, copy the file `data.raw` to your computer from the file location `\slot_{x}\data.raw`**

The x represents the slot in which the measurement module is installed.

**4 If you would like the data in ASCII format, copy the files corresponding to the labels you want to view from the file location `\slot_{x}\data.asc\{analyzer name}\{label name}.txt`**

Depending on which measurement module you are using, there might not be a subdirectory corresponding to an analyzer name.

**See Also**

Chapter 3 of the *HP 16500L LAN User's Guide* describes the contents of the binary `data.raw` file.



---

**Example**

You have an HP 16550A state/timing analyzer installed in slot C of your HP 16500B mainframe. The name of analyzer 1 of the HP 16550A is 68000\_BUS. You have created some labels under analyzer 1 of the HP 16550A, including one called "addr\_lo." The directory structure of the HP 16500B system looks like this:

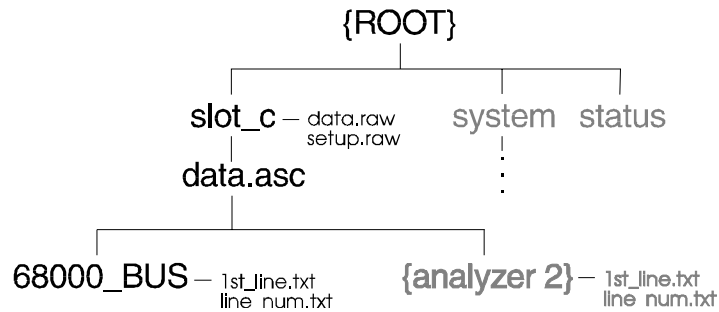

After setting up a measurement and acquiring data, you want to analyze the data for label addr\_lo on your PC. To copy the ASCII data to your local computer, enter the following command at the DOS prompt:

```
C:\ copy L:\slot_c\data.asc\68000_bus\addr_lo {local path name}
```

If you are using a UNIX system, you might use the **cp** command. In the Microsoft Windows environment, you can use the File Manager.

---

**See Also**

“Measurement Module Subdirectories,” in chapter 3 of the *HP 16500L LAN User’s Guide*, for more information about the files that are available for measurement modules.

---

## To transfer graphics files from the HP 16500B system to your computer

The current display of the HP 16500B is available in four different formats.

- 1 Set up the display you want to transfer.
- 2 Copy the file in the format of your choice from the directory `\system\graphics`.
  - The file `screen.tif` is a color Tagged Image File Format file, in TIFF version 5.0 format.
  - The file `screenbw.tif` is a black and white TIFF file in TIFF version 5.0 format.
  - The file `screen.pcx` is a color PCX file. (PCX is the standard format of PC Paintbrush and Publisher's Paintbrush.)
  - The file `screenbw.epi` is a black and white Encapsulated PostScript file in EPS version 3.0 format.

You can also save the current display to a file on one of the local HP 16500B disk drives, using the Print to Disk function. You can then transfer the file from the HP 16500B drive to your computer.

These graphics files contain the current display on the HP 16500B screen. The contents of the files change whenever you change the display. When you copy one of the graphics files, the display will freeze for a few moments while the HP 16500B is copying the current display.

---

### Example

To copy a PCX picture of the current screen display to your computer, enter the following command at the UNIX command prompt:

```
$ cp /logic/system/graphics/screen.pcx {local path name}
```

If you are using a DOS system, you can use the **copy** command. In the Microsoft Windows environment, you can use the File Manager.



Concepts

---

## Concepts



Understanding how the analyzer does its job will help you use it more effectively and minimize measurement problems. This chapter explains the general operation of the trigger sequencer and the inverse assembler.

---

# The Trigger Sequencer

Logic state and timing analyzer modules for the HP 16500B have triggering and data storage features that allow you to capture only the system activity of interest. Understanding how these features work will help you set up analyzer trigger specifications that satisfy your measurement needs.

There are several different logic analyzers available for the HP 16500B. This discussion will focus on the HP 16550A, a 100-MHz state/500-MHz timing analyzer. Most HP logic analyzers will be similar, differing only in the number of available states, pattern resources, range resources, and acquisition memory depth.

In the HP 16550A state analyzer, the trigger sequencer is a state machine with a minimum of two states and a maximum of twelve states. The trigger term can be any one of these states except the last. The analyzer searches for a trigger sequence by matching input values on the pods to branch conditions, which control transitions between states. You can insert or delete states to make the trigger sequence as simple or complex as needed for your application.

## **Trigger Sequence Specification**

See the following figure, which shows a sequence specification with four states. To define the trigger sequence, you specify sequence-advance, sequence-else, storage, and trigger-on specifications.

A sequence-else specification can branch to the same state...

to a previous state...

or a later state.

Sequence-Else Specifications

Sequence Level

Sequence-Advance Specifications

Sequence-advance specifications always branch to the next state.

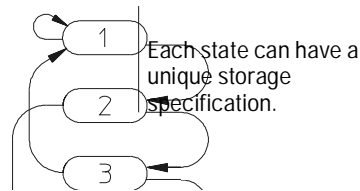

**State Analyzer Sequencer with Four States**

Each state, except for the last, has two branch conditions. These are the sequence-advance and sequence-else specification. (The trigger-on specification is a special sequence-advance specification that is described in the section “TRIGGER On Specification.”)

**Sequence-Advance Specification**

The sequence-advance branch, sometimes called the “if” branch or primary branch, always branches to the next higher-numbered state. You can specify the following kinds of sequence-advance specifications:

Find (or Then find) “<TERM>” <OCCURS> time(s)

Find (or Then find) “<TERM>” <TIME PERIOD>

If the Find (or Then find) “<TERM>” is found <OCCURS> number of times, the sequencer advances to the next sequence level.

If the <TERM> remains stable for <TIME PERIOD>, the sequencer advances to the next sequence level.

**Sequence-Else Specification**

The sequence-else branch, sometimes called the “else if” branch or secondary branch, may branch to any other state, including the current state, a previous state, or a later state. The sequence-else specification looks like the following:

```
Else on "<TERM>" go to level <sequence level>
```

If the Sequence-Else specification is satisfied before the sequence-advance specification is satisfied, the sequencer begins at <sequence level>.

The last state may only have a sequence-else branch specification, which may branch to the same state or a prior state.

**Storage Specification**

In each state, a storage specification determines the data stored by the analyzer while it is searching for the sequence-advance, sequence-else, and trigger specifications. Storage specifications are defined using the same pattern, range, and timer resources available for defining branching specifications.

```
While storing "anystate", "no state", or "<TERM>"
```

Note that if you specify “no state,” the analyzer still stores sequence-advance terms and TRIGGER terms.

**TRIGGER On Specification**

If there are branch and storage specifications for each sequence level, what does the trigger term mean? The trigger term is a special sequence-advance specification in that, when found, it locks the contents of analyzer acquisition memory. The trigger can be positioned at the beginning, middle, or end of acquisition memory.

The trigger specification can look like the following:

```
TRIGGER on "<TERM>" <OCCURS> times
```

```
TRIGGER on "<TERM>" <TIME PERIOD>
```

If the trigger term is found <OCCURS> times, or if the trigger term remains stable for <TIME PERIOD>, the trigger is captured in memory. Then the sequencer advances to the next sequence level. If

you want to capture activity after the trigger is captured, define an additional sequence level and specify the desired storage qualification for post-trigger activity (for example, store “anystate”).

### **Analyzer Resources**

The sequence-advance, sequence-else, storage, and trigger-on specifications are set by a combination of up to 10 pattern terms, 2 range terms, and 2 timers. Different analyzer models may vary in the number of resources available.

#### **10 Pattern Terms**

The pattern terms, a through j, represent single states to be found on labeled sets of bits. For example, you could have an address on the address bits or a status on the status bits.

#### **2 Timers**

You can start, stop, continue, or pause the timers upon entry to a sequence state, then use a comparison of current timer value against a preset value to determine whether to branch to another state.

#### **2 Range Terms**

The range terms, Range1 and Range2, represent ranges of values to be found on labeled sets of bits. For example, you could have a range of addresses to be found on the address bus or a range of data values to be found on the data bus. Range terms are satisfied by any value within the range for “In\_Range,” and any value outside the range for “Out\_Range.”

You can combine the pattern terms and range terms with logical operators to form complex pattern expressions in the sequence-advance, sequence-else, and TRIGGER on specifications.

For example,

```
Find "<TERM1>+<TERM2>" OR <TERM1> and <TERM2>
```

```
Find "<TERM1>.<TERM2>" AND <TERM1> and <TERM2>
```



Where <TERM> can be a single value on a set of labels, any value within a range of values on a set of labels, or a glitch or edge transition on a bit or set of bits.

**Limitations Affecting Use of Analyzer Resources**

There are limitations on the way resources can be combined to form complex pattern expressions. Resources are combined in a four-level hierarchy. First, resources are divided into two groups. The groups can be combined with AND or OR. Second, within these groups, resources are combined into pairs. Pairs can also be logically combined using AND or OR. Third, individual resources are combined into pairs using AND, NAND, OR, NOR, XOR, NXOR. Fourth, individual resources may be included or excluded from participating in a pattern expression. You can also include the logical negation of the resource.

The following table shows how resources are divided in the HP 16550A. Remember that some resources may not be available, depending on the analyzer configuration. For example, if you are using the analyzer as a state analyzer, the Edge1 and Edge2 resources are not available. If the timers are off, the Timer1 and Timer2 resources are not available.

Can combine groups with AND or OR															
Group 1								Group 2							
Can combine pairs with AND or OR within a group															
Pair 1				Pair 2				Pair 3				Pair 4			
Combine Resources into pairs using AND, NAND, OR, NOR, NXOR															
Include or ExcludeResources															
on, off, negate	on, off, negate	on, off, negate	off, in range, out of range	on, off, negate	on, off, negate	on, off, negate	off, >, <	on, off, negate	on, off, negate	on, off, negate	off, in range, out of range	on, off, negate	on, off, negate	on, off, negate	off, >, <
a	b	c	Range1	d	Edge1	e	Timer1	f	g	h	Range2	i	Edge2	j	Timer2

## Concepts

So, the following combinations are valid combinations for the state analyzer, if timers are on:

$$(a+b) \cdot (In\_Range2 + Timer2 > 400 \text{ ns})$$
$$(c \cdot Out\_Range1) + (f \text{ xor } g)$$

The following combinations are not valid, because resources cross pair boundaries:

$$(a + c)$$
$$(d + Timer1 < 400 \text{ ns})$$

The first example shows that a and c cannot be combined at the first level. You can get around this, however, by combining them at the second level. The following figure shows the possible combinations of the a, b, c and Range1 terms:

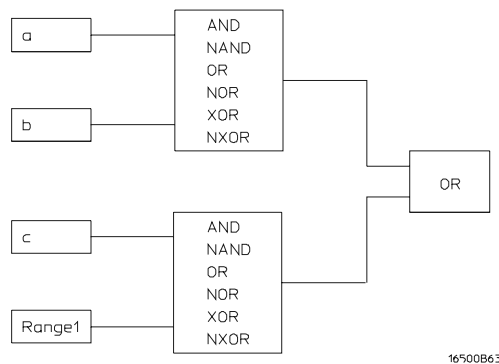

### Combining a, b, c, and Range1 Terms

The following combination is not valid, because pairs cross group boundaries:

$$((a+b) + (h \cdot In\_Range2)) \cdot (j \text{ xor } Timer2 > 400 \text{ ns})$$

Note that the analyzer interface will not allow you to enter invalid combinations, however, you need to be aware of what combinations are legal, so that you can make the desired measurement.

Another limitation is that the analyzer cannot handle ranging for input pods that are assigned to different analysis IC's. For example, if you need to define a 32-bit range term, you must do it using pods 1/2, 3/4,

or 5/6. Trying to define a range across pods 2/3, 4/5, or 1/6 will not work.

### **The Timing Analyzer**

When you configure the HP 16550A as a timing analyzer, the trigger sequencer is similar. However, there are between 1 and 10 states available. The trigger term is always the last state. There are two additional resources, Edge1 and Edge2. These can recognize occurrences of a glitch, or occurrences of a rising edge, falling edge, either edge, or no edge on a bit or ORed set of bits represented by a glitch/edge term.



---

## The Inverse Assembler



When the analyzer captures a trace, it captures binary information. The analyzer can then present this information in binary, octal, decimal, hexadecimal, or ASCII. Or, if given information about the meaning of the data captured, the analyzer can *inverse assemble* the trace. The inverse assembler makes the trace list more readable by presenting the trace results in terms of processor opcodes and data transactions.

The inverse assembly software needs five pieces of information:

- Address bus. The inverse assembler expects to see the label ADDR, with bits ordered in a particular sequence.
- Data bus. The inverse assembler expects to see the label DATA, with bits ordered in a particular sequence.
- Status. The inverse assembler expects to see the label STAT, with bits ordered in a particular sequence.
- Start state for disassembly. This is the first displayed state in the trace list, *not* the cursor position. See the figure below.
- Tables indicating the meaning of particular status and data combinations.

When you press the Invasm key to begin inverse assembly of a trace, the inverse assembler begins with the first displayed state in the trace list. This is called *synchronization*. It looks at the status bits (STAT) and determines the type of processor operation, which is then displayed under the STAT label. If the operation is an opcode fetch, the inverse assembler uses the information on the data bus to look up the corresponding opcode in a table, which is displayed under the DATA label. If the operation is a data transfer, the data and corresponding operation are displayed under the DATA label. This continues for all subsequent states in the trace list.

100/500MHz LA B		Listing 1	Invasm	Print	Run
Markers Off		Acquisition Time 27 Oct 1993 10:25:55			
Label>	ADDR	CPU32 Mnemonic		STAT	
Base>	Hex	hex		Symbol	
-7	41CE6	MOVE.B	(A7)+,D0	Opcode Fetch	
-6	41CE8	MOVE.B	D0,SWITCH R	Opcode Fetch	
-5	0FF7E	09xx	data read	Data Read	
-4	41CEA	0000	pgm read	Opcode Fetch	
-3	41CEC	8100	pgm read	Opcode Fetch	
-2	41CEE	MOVE.B	D0,-(A7)	Opcode Fetch	
-1	41CF0	BSR.W	00040A40	Opcode Fetch	
0	08100	09xx	data write	Data Write	
1	41CF2	ED4E	pgm read	Opcode Fetch	
2	0FF7E	09xx	data write	Data Write	
3	0FF7A	0004	data write	Data Write	
4	0FF7C	1CF4	data write	Data Write	
5	40A40	MOVE.L	D0,-(A7)	Opcode Fetch	
6	40A42	8000	pgm read	Opcode Fetch	
7	40A44	MOVE.B	(0008,A7),D0	Opcode Fetch	
8	40A46	0008	pgm read	Opcode Fetch	

The inverse assembler synchronizes at the first line in the trace list...

not at the cursor position

**Inverse Assembly Synchronization**

If you roll the trace list to a new position and press Invasm again, the inverse assembler repeats the above process. However, it does not work backward in the trace list from the starting position. This may cause differences in the trace list above and below the point where you synchronized inverse assembly. The best way to ensure correct inverse assembly is to synchronize using the first state you know to be the first byte of an opcode fetch.

For processors with a pipeline or instruction queue, the information presented to the analyzer can potentially become confusing. Was an instruction executed or not? Active circuitry on some preprocessor models helps by sorting out the order of execution before presenting information to the analyzer. You can set switches on the preprocessor to control whether this dequeuing is enabled.

### Symbols

When you specify symbols as the format for displaying the address bus in the trace list, the symbol lookup happens independently of inverse assembly. Thus, you can have symbols in the address field without inverse-assembled data and status. The HP E2450A symbol download utility allows you to download symbols from OMF (Object Module Format) files.

### See Also

The *Preprocessor User's Guide* for more information on switch settings.

Chapter 5, "If You Have a Problem," if you have problems using the inverse assembler.

---

## Configuration Translation for Analyzer Modules

Configuration files provide an easy way for you to save and restore measurement setups, simplifying repeated measurements. However, sometimes you might change analyzer modules in the HP 16500B Logic Analysis System to gain additional measurement features. Or, you might want to use a configuration file from one HP 16500B system on another HP 16500B with a different analyzer module. But, the analyzer configuration files cannot be transferred directly from one type of analyzer to the next. Each analyzer has internal architectural differences, reflected in the number of pods, clock configurations, trigger sequencer features, analyzer resources, and so on.

To help you move configuration files from one analyzer to another, some analyzer measurement modules for the HP 16500B Logic Analysis System support automatic translation of analyzer configurations. If you save an analyzer configuration from one kind of analyzer module, then load that configuration into a module that supports configuration translation, the translator will adjust the configuration as required to account for differences between the modules.

The configuration translator needs to account for many aspects of the analyzer architecture. Some of the considerations are as follows:

- For some analyzers, demultiplexing data will require separate analyzer pods, because a master clock and a slave clock can't be assigned on the same pod to perform the demultiplexing. The translator may display messages on the analyzer screen that ask you to reconnect pod cables in a different configuration.
- When a range term is split across multiple pods, the term must span adjacent odd/even pairs, starting with 1. Thus, terms could span pods 1 and 2, 3 and 4, 5 and 6, or 7 and 8, but not 2 and 3. Again, the translator may display messages asking you to reconnect cables in a different configuration.
- When loading a configuration into an analyzer with fewer pods than the one on which the configuration was saved, the translator must

remove pod assignments. Which pods are removed from the configuration will depend on the widths of each pod in the original analyzer and new analyzer.

The configuration translation also needs to account for many differences in the format and trace menus between the analyzers, including

- label names,
  - polarities,
  - thresholds,
  - symbols,
  - clocking,
  - number of sequence levels,
  - branch conditions, and
  - patterns,
- among others.

To ensure that trace measurements act as expected when you move configuration files from one analyzer to another, follow these recommendations:

- Ensure that the analyzer pods are hooked up as required by the configuration translation and the new analyzer. The onscreen messages given by the translator will help you identify which analyzer pods must be swapped. If you are using an HP preprocessor, the *Preprocessor User's Guide* may contain information showing the cable connections for different analyzer modules.
- Review all trace format and trigger menu settings to verify that they will meet your measurement requirements. You should check label assignments, channel masks, pattern and range definitions, sequencer setup, and general analyzer configuration (which pods are mapped to each analyzer).



When you move a configuration file from one analyzer to another, the trace data from previous measurements is not moved. If you need to store trace data for future reference, see "To save a trace list in ASCII format" in chapter 3.







If You Have a Problem

---

# If You Have a Problem

Occasionally, a measurement may not give the expected results. If you encounter difficulties while making measurements, use this chapter to guide you through some possible solutions. Each heading lists a problem you may encounter, along with some possible solutions. Error messages which may appear on the logic analyzer are listed below in quotes “ ”. Symptoms are listed without quotes.

If you still have difficulty using the analyzer after trying the suggestions in this chapter, please contact your local Hewlett-Packard service center.

---

**CAUTION**

---

When you are working with the analyzer, be sure to power down both the analyzer and the target system before disconnecting or connecting cables, probes, and preprocessors. Otherwise, you may damage circuitry in the analyzer, preprocessor, or target system.

---

## Analyzer Problems

This section lists general problems that you might encounter while using the analyzer.

---

### Intermittent data errors

This problem is usually caused by poor connections, incorrect signal levels, or marginal timing.

- ❑ Remove and reseal all cables and probes; ensure that there are no bent pins on the preprocessor interface or poor probe connections.
- ❑ Adjust the threshold level of the data pod to match the logic levels in the system under test.
- ❑ Use an oscilloscope to check the signal integrity of the data lines.

Clock signals for the state analyzer must meet particular pulse shape and timing requirements. Data inputs for the analyzer must meet pulse shape and setup and hold time requirements.

#### See Also

See “Capacitive Loading” in this chapter for information on other sources of intermittent data errors.

---

### Unwanted triggers

Unwanted triggers can be caused by instructions that were fetched but not executed.

- ❑ Add the prefetch queue or pipeline depth to the trigger address to avoid this problem.

The depth of the prefetch queue depends on the processor that you are analyzing. Suppose you are analyzing a pipelined processor having fetch, decode, execute, and memory stages. The processor fetches 32-bit words. To ensure that the processor has begun executing a particular routine when the trigger occurs, set the trigger to the module entry address plus 08 hex. (This assumes that there is no immediate data in the instruction stream.)

---

---

## No Setup/Hold field on format screen

The HP 16540 and 16541 (A and D models), or HP 16542A logic analyzer cards are not calibrated. Refer to your logic analyzer reference manual for procedures to calibrate the cards.

---

## No activity on activity indicators

- ❑ On the HP 16510A Logic Analyzer, check the fuse that allows power to the preprocessor interface.
- ❑ On other logic analyzers, check for loose cables, board connections, and preprocessor interface connections.
- ❑ Check for bent or damaged pins on the preprocessor probe.

---

## Capacitive loading

Excessive capacitive loading can degrade signals, resulting in incorrect capture by the preprocessor interface, or system lockup in the microprocessor. All preprocessor interfaces add additional capacitive loading, as can custom probe fixtures you design for your application.

Careful layout of your target system can minimize loading problems and result in better margins for your design. This is especially important for systems that are running at frequencies greater than 50 MHz.

- ❑ Remove as many pin protectors, extenders, and adapters as possible.
- ❑ If multiple preprocessor interface solutions are available, try using one with lower capacitive loading.

### See Also

Chapter 6 lists some application notes that discuss the problems of probing high-speed digital systems.

---

## No trace list display

If there is no trace list display, it may be that your analysis specification is not correct for the data you want to capture, or that the trace memory is only partially filled.

- ❑ Check your analysis sequencer specification to ensure that it will capture the events of interest.
- ❑ Try stopping the analyzer; if the trace list is partially filled, this should display the contents of trace memory.

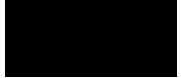

---

## Preprocessor Problems

This section lists problems that you might encounter when using a preprocessor. If the solutions suggested here do not correct the problem, you may have a defective preprocessor. Refer to the *User's Guide* for your preprocessor for test procedures. Contact your local Hewlett-Packard Sales Office if you need further assistance.

---

### Target system will not boot up

If the target system will not boot up after connecting the preprocessor interface, the microprocessor or the preprocessor interface may not be installed properly, or they may not be making electrical contact.

- Ensure that you are following the correct power-on sequence for the preprocessor and target system.

- 1 Power up the analyzer and preprocessor.
- 2 Power up the target system.

If you power up the target system before you power up the preprocessor, interface circuitry in the preprocessor may latch up, preventing proper target system operation.

- Verify that the microprocessor and the preprocessor interface are properly rotated and aligned, so that the index pin on the microprocessor (such as pin 1 or A1) matches the index pin on the preprocessor interface.
- Verify that the microprocessor and the preprocessor interface are securely inserted into their respective sockets.
- Verify that the logic analyzer cables are in the proper sockets of the preprocessor interface and are firmly inserted.
- Reduce the number of extender sockets.

#### See Also

“Capacitive Loading” in this chapter.



---

## Slow clock

If you have the preprocessor interface hooked up and running and observe a slow clock or no activity from the interface board, the +5 V supply coming from the analyzer may not be getting to the interface board.

- To check the +5 V supply coming from the analyzer, disconnect one of the logic analyzer cables from the preprocessor and measure across pins 1 and 2 or pins 39 and 40.

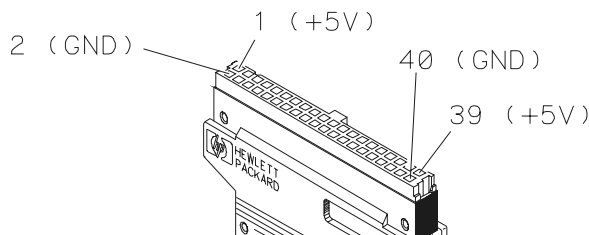

- If +5 V is not present, check the internal preprocessor fuse or current limiting circuit on the logic analyzer. For information on checking this fuse or circuit, refer to the *Service Guide* for your logic analyzer.
- If +5 V is present and the cable connection to the preprocessor appears sound, contact your nearest Hewlett-Packard Sales Office for information on servicing the board.

---

## Erratic trace measurements

There are several general problems that can cause erratic variations in trace lists and inverse assembly failures.

- Ensure that the preprocessor configuration switches are correctly set for the measurement you are trying to make.

Some preprocessors include configuration switches for various features (for example, to allow dequeuing of the trace list). See your *Preprocessor User's Guide* for more information.

If You Have a Problem  
**Erratic trace measurements**

- ❑ **Try doing a full reset of the target system before beginning the measurement.**

Some preprocessor designs require a full reset to ensure correct configuration.

- ❑ **Ensure that your target system meets the timing requirements of the processor with the preprocessor probe installed.**

See “Capacitive Loading” in this chapter. While preprocessor loading is slight, pin protectors, extenders, and adapters may increase it to unacceptable levels. If the target system design has poor timing margins, such loading may cause incorrect processor functioning, giving erratic trace results.

- ❑ **Ensure that you have sufficient cooling for the preprocessor probe.**

Current processors such as the i486, Pentium™, and MC68040 generate substantial heat. This is exacerbated by the active circuitry on the preprocessor board. You should ensure that you have ambient temperature conditions and airflow that meet or exceed the requirements of the microprocessor manufacturer.

---

## Inverse Assembler Problems

This section lists problems that you might encounter while using the inverse assembler.

When you obtain incorrect inverse assembly results, it may be unclear whether the problem is in the preprocessor or in your target system. If you follow the suggestions in this section to ensure that you are using the preprocessor and inverse assembler correctly, you can proceed with confidence in debugging your target system.

---

### No inverse assembly or incorrect inverse assembly

This problem is due to incorrect synchronization, modified configuration, incorrect connections, or a hardware problem in the target system. A locked status line can cause incorrect or incomplete inverse assembly.

- ❑ **Verify that the inverse assembler has been synchronized by placing an opcode at the top of the display (not at the input cursor) and pressing the Invasm key.**

Because the inverse assembler works from the first line of the trace *display*, if you jump to the middle of a trace and select Invasm, prior trace states are not disassembled correctly. If you move to several random places in the trace list and select Invasm each time, the trace disassembly is only guaranteed to be correct from the top of the display forward for each selection.

- ❑ **Ensure that each analyzer pod is connected to the correct preprocessor cable.**

There is not always a one-to-one correspondence between analyzer pod numbers and preprocessor cable numbers. Preprocessors must supply address (ADDR), data (DATA), and status (STAT) information to the analyzer in a predefined order, so the cable connections for each preprocessor are often altered to support that need. Thus, one preprocessor might require that you connect cable 2 to analyzer pod 2, while another will require you to connect cable 5 to analyzer pod 2. See the *User's Guide* for your preprocessor for further information.

If You Have a Problem  
**Inverse assembler will not load or run**

- ❑ Check the activity indicators for status lines locked in a high or low state.

- ❑ Verify that the STAT, DATA, and ADDR format labels have not been modified from their default values.

These labels must remain as they are configured by the configuration file. Do not change the names of these labels or the bit assignments within the labels. Some preprocessors also require other data labels; check your *Preprocessor User's Guide* for more information.

- ❑ Verify that all microprocessor caches and memory managers have been disabled.

In most cases, if the microprocessor caches and memory managers remain enabled you should still get inverse assembly, but it may be incorrect since some of the execution trace was not visible to the logic analyzer.

- ❑ Verify that storage qualification has not excluded storage of all the needed opcodes and operands.

---

## **Inverse assembler will not load or run**

You need to ensure that you have the correct system software loaded on your analyzer.

- ❑ Ensure that the inverse assembler is on the same disk as the configuration files you are loading.

Configuration files for the state analyzer contain a pointer to the location of the corresponding inverse assembler. If you delete the inverse assembler or move it to another location, the configuration process will fail.

- ❑ Make sure you are using the version of the inverse assembler software that corresponds to the operating system revision installed on your analyzer.

See your *Preprocessor User's Guide* for details.

---

## Intermodule Measurement Problems

Some problems occur only when you are trying to make a measurement involving multiple modules.

---

### An event wasn't captured by one of the modules

If you are trying to capture an event that occurs very shortly after the event that arms one of the measurement modules, it may be missed, due to internal analyzer delays. For example, suppose you set the oscilloscope to trigger upon receiving a trigger signal from the logic analyzer, because you are trying to capture a pulse that occurs right after the analyzer's trigger state. If the pulse occurs too soon after the analyzer's trigger state, the oscilloscope will miss the pulse.

- ❑ **Adjust the skew in the Intermodule menu.**

You may be able to specify a skew value that enables the event to be captured.

- ❑ **Change the trigger specification for modules upstream of the one with the problem.**

If you're using a logic analyzer to trigger the scope, try specifying a trigger state one state before the one you are using. This may be more difficult than working with the skew, because the prior state may occur more often and not always be related to the event you're trying to capture with the oscilloscope.

---

## Messages

This section lists some of the messages that the analyzer displays when it encounters a problem.

---

### “Default Calibration Factors Loaded” (HP 16540, 16541, and 16542)

The default calibration file for the logic analyzer was loaded. The logic analyzer must be calibrated when using HP 16540A,D, HP 16541A,D or HP 16542A cards. Refer to the *Logic Analyzer Reference* for procedures to calibrate the master clocking system, and ensure that the “cal factors” file is saved. Refer to the *Logic Analyzer Reference* manual for procedures to calibrate the cards.

---

### “. . . Inverse Assembler Not Found”

This error occurs if you rename or delete the inverse assembler file that is attached to the configuration file. Ensure that the inverse assembler file is not renamed or deleted.

---

## "Measurement Initialization Error"

This error occurs when you have installed the cables incorrectly for one or two HP 16550A logic analysis cards. The following diagrams show the correct cable connections for one-card and two-card installations. Ensure that your cable connections match the drawing, then repeat the measurement.

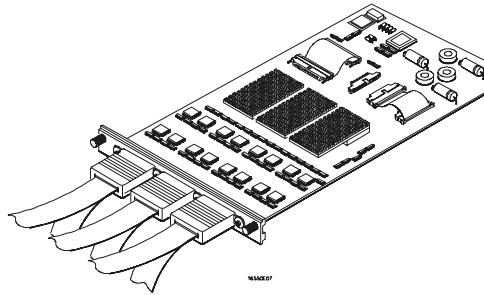

Cable Connections for One-Card HP 16550A Installations

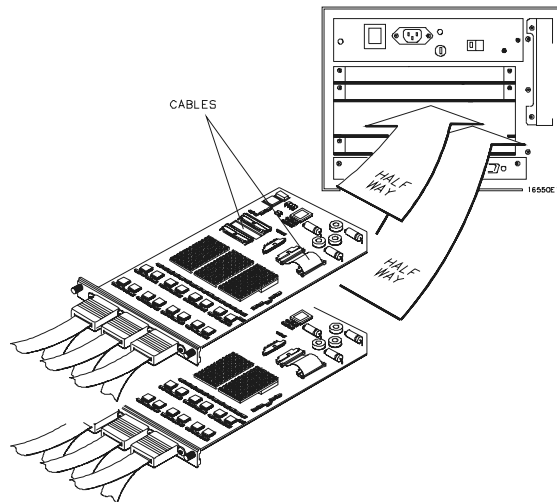

Cable Connections for Two-Card HP 16550A Installations

**See Also**

The *HP 16550A 100-MHz State/500-MHz Timing Logic Analyzer Service Guide*.

---

## “No Configuration File Loaded”

This is usually caused by trying to load a configuration file for one type of module or the system into a different type of module.

- ❑ Verify that the appropriate module has been selected from the Load {module} from File {filename} in the HP 16500A,B disk operation menu. Selecting Load {All} will cause incorrect operation when loading most preprocessor interface configuration files.



**See Also**

“To Load a Configuration File” in chapter 3, “File Management.”

---

## “Selected File is Incompatible”

This occurs when you try to load a configuration file for the wrong module. Ensure that you are loading the appropriate configuration file for your logic analyzer.

---

## “Slow or Missing Clock”

- ❑ This error message might occur if the logic analyzer cards are not firmly seated in the HP 16500A/B or HP 16501A frame. Ensure that the cards are firmly seated.
- ❑ This error might occur if the target system is not running properly. Ensure that the target system is on and operating properly.
- ❑ If the error message persists, check that the logic analyzer pods are connected to the proper connectors. See the *User's Guide* for your preprocessor interface to determine the proper connections.
- ❑ For HP 16510A Logic Analyzers, check the preprocessor interface power fuse in the logic analyzer.



---

## “State Clock Violates Overdrive Specification”

At least one 16-channel pod in the state analysis measurement stored a different number of states before trigger than the other pods. This is usually caused by sending a clocking signal to the state analyzer that does not meet all of the specified conditions, such as minimum period, minimum pulse width, or minimum amplitude. Poor pulse shaping could also cause this problem.

The error message “State Clock Violates Overdrive Specification” should occur only for HP 16510A,B, and HP 16511B Logic Analyzers with the Clock Period field set to <60 ns. If this error message is observed with the Clock Period set to >60 ns, you may have a faulty logic analyzer. If a failure is suspected in your logic analyzer, contact your nearest Hewlett-Packard Sales Office for information on servicing the instrument.

---

## “Time from Arm Greater Than 41.93 ms”

The state/timing analyzers have a counter to keep track of the time from when an analyzer is armed to when it triggers. The width and clock rate of this counter allow it to count for up to 41.93 ms before it overflows. Once the counter has overflowed, the system does not have the data it needs to calculate the time between module triggers. The system must know this time to be able to display data from multiple modules on a single screen.

---

## “Waiting for Trigger”

If a trigger pattern is specified, this message indicates that the specified trigger pattern has not occurred. Verify that the triggering pattern is correctly set.

- When analyzing microprocessors that fetch only from long-word aligned addresses, if the trigger condition is set to look for an opcode fetch at an address not corresponding to a long-word boundary, the trigger will never be found.

If You Have a Problem  
**“Waiting for Trigger”**

If a “don't care” trigger condition is set, this message indicates:

- For an HP 16511B Logic Analyzer, only one of the two cards is receiving its state clock. Refer to “Slow or Missing Clock.”
- For an HP 16510A,B Logic Analyzer, the pattern duration is probably set to less than (<) instead of greater than (>). Since a “don't care” pattern is always true, the “less than” condition is never satisfied. Set the trigger correctly for the measurement that is desired.





---

## Application Notes

---

## Application Notes

Hewlett-Packard has prepared several application notes and product notes that show you how to get more out of your HP 16500B Logic Analysis System. Each note focuses on a particular application or problem, showing you the components of the problem, the approach required to solve it, the instrumentation, and the measurement results.

The following table lists the application notes and product notes relevant to the HP 16500B Logic Analysis System. To order, contact your local Hewlett-Packard Sales Office.

---

### Application Notes and Product Notes

---

Note Number	HP Part Number	Title	Description
Application Note 392-1	5952-3056	<i>Aerospace and Defense Applications: How the Right Preprocessor Interface Can Simplify Logic Analysis</i>	These four notes in the 392 series discuss how using a preprocessor with your logic analyzer can simplify measurements; each is related to a different application domain.
Application Note 392-3	5952-3058	<i>VME/VXI Applications: How the Right Preprocessor Interface Can Simplify Logic Analysis</i>	
Application Note 392-5	5952-3060	<i>Computer Peripheral Applications: How the Right Preprocessor Interface Can Simplify Logic Analysis</i>	
Application Note 392-6	5952-3284	<i>Industrial/Automotive Applications: How the Right Preprocessor Interface Can Simplify Logic Analysis</i>	
Application Note 1210-2	5091-1800E	<i>Understanding and Minimizing Probing Effects</i>	Discusses probe loading effects in a digitizing oscilloscope measurement. Also applies to logic analyzers.
Application Note 1223	5091-4121E	<i>Logic Analyzer Triggering Applications</i>	Shows a variety of different triggering examples using the HP 16550A state/timing analyzer.

Note Number	HP Part Number	Title	Description
Application Note 1225-1	5091-5445E	<i>Imaging and DSP Testing with the HP 16542A</i>	Shows how to use the HP 16542A deep memory state and timing module in digital signal processing applications, such as verifying a digital filter and troubleshooting distortion on a video display.
Application Note 1225-2	5091-5446E	<i>Cache Hit or Miss Analysis with the HP 16542A</i>	Shows how to analyze cache hit rate using the HP 16520A Pattern Generator with the HP 16542A deep memory state and timing module.
Application Note 1225-3	5091-5447E	<i>Digital Video Testing with the HP 16542A</i>	Uses the deep memory of the HP 16542A with the complex triggering capabilities of that module and of the 16550A state/timing analyzer to capture and analyze data from a digital video stream.
Application Note 1225-4	5091-5448E	<i>Analog-to-Digital Converter Testing With the HP 16542A</i>	Uses the deep memory and high-speed capture capabilities of the HP 16542A to do differential non-linearity testing of an analog-to-digital converter.
Application Note 1244-1	5091-6802E	<i>Minimizing Intrusion Effects When Probing with a Logic Analyzer</i>	Discusses physical and electrical considerations for probing circuits with an analyzer.
Product Note 16520A/21A-1	5952-1676	<i>Digital Verification with the HP 16520/21A Pattern Generator</i>	Shows how to use the pattern generator with the timing analyzer to do board verification.
Product Note 54720A-3	5091-3758E	<i>Selecting Oscilloscope Probes for High-Speed Digital Circuit Measurements</i>	Discusses loading effects of probes on digital circuitry. Very relevant to probing for logic state and timing analysis as well.
(Preliminary: contact HP for details)	N/A	<i>PC Network Connectivity with the HP 16500L Interface</i>	Explains how to connect the HP 16500B to networks supporting the TCP/IP and NFS protocols.



---

## Glossary

<b>acquisition</b>	Denotes one complete cycle of data gathering by a module. For example, in the HP 16532 oscilloscope, one complete cycle gathers 8000 samples of information and stores them in acquisition memory.	receive their arm signal. The arm signal is usually used to coordinate measurement start between two or more measurement modules.
<b>arm</b>	The arm output from a module is set false when the module begins running and is set true when the module finds its trigger condition. Other measurement modules that take the arm signal as an input are unable to capture data or search for their triggers until they	
		<b>attenuation factor</b> <i>See</i> probe field.
		<b>autoscale algorithm</b> An algorithm for oscilloscope modules that, based on the amplitude and period of the signals found, sets the vertical sensitivity in volts per division, offset, horizontal sweep speed in seconds per division, trigger level, and trigger slope for the trigger input. Its purpose is to set up the



	system so that two to five cycles of the input waveform are displayed on the screen. The waveform is from the lowest numbered and lettered channel with a signal.		present configuration.
<b>cancel autoscale</b>	The field that allows you to cancel an autoscale command. This field is particularly important if you inadvertently select the Autoscale field when you have your measurement configuration set. Automatically scaling your signals at this point could change your	<b>cancel run</b>	The field that allows you to cancel making an oscilloscope run for any reason once you have selected the Run field.
		<b>coupling field</b>	The field that sets the input impedance for the signal applied to oscilloscope channels. For example, in the HP 16532A, the input coupling can be set to 1 Mohm/DC, 1 Mohm/AC, and 50 ohm/DC.
		<b>cross triggering</b>	Using intermodule capabilities to have measurement modules trigger each



	<p>other. For example, you can have an external instrument arm a logic analyzer, which subsequently triggers an oscilloscope when it finds the trigger state.</p>	<p><b>deskewing</b></p>	<p>To cancel or nullify the effects of differences between two different internal delay paths for a signal. Deskewing is normally done by routing a single test signal to the inputs of two different modules, then adjusting the delay path to one of the modules so that both modules recognize the signal at the same state at the same time.</p>
<p><b>delay field</b></p>	<p>The field that sets the horizontal position of the waveform on the screen for the oscilloscope and timing analyzer. Delay time is measured from the trigger point. It is measured in seconds, can be viewed in the Delay field, and is set by using the knob or the keypad.</p>	<p><b>don't care</b></p>	<p>Signifies that the state of the signal, high or low, is not relevant to the measurement. That is, the analyzer will</p>



	ignore the state of this signal when determining whether a match occurs on an input label. Don't cares are represented by the X character in analyzer resource terms.		either edge, no edge, or glitch (very short duration pulse) on an input signal. <i>See also</i> glitch.
<b>edge mode</b>	In the oscilloscope, this is the trigger mode that causes a trigger based on a single channel edge (either rising or falling).	<b>glitch</b>	A glitch is defined as two or more transitions crossing the logic threshold between consecutive timing analyzer samples.
<b>glitch/edge terms</b>	Timing analyzer resources that allow detection of transitions on a signal. A glitch/edge term can be set to detect a rising edge, falling edge,	<b>high</b>	The most-positive portion of a logic signal. In pattern trigger measurements for the oscilloscope, it is represented by an H in the pattern selector.
		<b>horizontal position</b>	<i>See</i> delay field.

<b>horizontal sweep speed</b>	the oscilloscope, the time value that determines horizontal scaling of the waveform to be displayed on the screen. It is measured in seconds per division and is viewed in the s/Div field. It is set by using the knob or the keypad.		vertical scaling.
		<b>input impedance</b>	<i>See</i> coupling field.
		<b>intermodule menu</b>	The menu that allows you to set up the instrument to make interactive measurements, either with other modules in the mainframe or with external modules.
<b>immediate mode</b>	In the oscilloscope, the trigger mode that does not require a specific trigger condition (that is, an edge or a pattern).	<b>labels</b>	Labels are the names of pods/bits that are used to identify signal channels or buses. A label is assigned to identify a bit or set of bits.
<b>input field</b>	In the oscilloscope, the field that allows you to select a channel for	<b>low</b>	The most-negative portion of a logic signal. Used in pattern trigger measurement

s, it is represented by an L in the pattern selector.

**manual markers mode** The marker mode for the timing analyzer and oscilloscope that lets you manually move the markers using the knob or the keypad. It is accessed by selecting the Markers field.

**menu field** The field to the immediate right of the module field (*see* module field). It allows you to choose the menus related to the module shown in the module field.

**module field** The field in the upper-left corner of the screen. It allows you to

**offset field**

choose any of the modules in the mainframe as the working module. It also allows you to choose system options and intermodule options.

For the oscilloscope, the field that sets the vertical position of the waveform on the screen. Offset is the voltage represented at the center vertical tick mark in the waveform display. It is measured in volts and is viewed in the Offset field. It is set by using the knob or the keypad.

**panning**

The action of moving the

	<p>waveform along the timebase by varying the delay value in the Delay field. This action allows you to control the portion of acquisition memory that will be displayed on the screen. If you choose, you can view the entire waveform record in acquisition memory. This is normally done in single-shot mode.</p>		<p>Contrast <i>pattern terms</i>.</p>
<b>pattern mode</b>	<p>For the oscilloscope, the trigger mode that allows you to set oscilloscope to trigger on a specified combination of input signal levels.</p>	<b>pattern terms</b>	<p>Analyzer resources that represent single states to be found on labeled sets of bits; for example, an address on the address bus or a status on the status lines.</p>
		<b>probe field</b>	<p>For the oscilloscope, the field that sets the probe attenuation factor. For example, in the HP 16532A, the input attenuation can be set from 1:1 to 1000:1 in increments of 1.</p>
		<b>range terms</b>	<p>In the analyzer, the range terms represent</p>

ranges of values to be found on labeled sets of bits. For example, a range of addresses to be found on the address bus or a range of data values to be found on the data bus. Range terms are satisfied by any value within the range for “In\_Range,” and by any value outside the range for “Out\_Range.”

**repetitive mode**

The field that causes the selected measurement modules to begin the next acquisition as soon as the previous acquisition is completed and displayed.

**run, repetitive mode** *See* repetitive mode.

**run, single mode** *See* single mode.

**s/Div** *See* horizontal sweep speed.

**sequence-advance specification**  
In the

analyzers, the combination of patterns, occurrences, and time that must be satisfied before the trigger sequencer will advance from the current sequencer state to the next higher-numbered sequencer state.

**sequence-else specification**

analyzers, the combination of patterns that will cause the trigger sequencer to transition to another sequencer state from the current state, if the sequence-advance specification has not been found to this point.

**sequence**

The logic analyzer trigger sequencer is a state machine that determines when the analyzer will

	<p>trigger. All of the transition matches that lead to the trigger state must be satisfied before the analyzer will trigger. The sequence is defined by the sequence-advance, sequence-else, and storage specifications currently in effect.</p>		<p>select the Run field each time you want a new acquisition and corresponding screen update.</p>
<b>single mode</b>	<p>The field that causes a measurement module or system of measurement modules to make a single data acquisition, then display the results of that acquisition on the screen. In this mode, you must</p>	<b>skew</b>	<p>Skew is the difference in channel delays between measurement channels. Typically, skew between modules is caused by differences in designs of measurement channels, and differences in characteristics of the electronic components within those channels. You should adjust measurement modules to eliminate as much skew as possible so</p>

that it does not affect the accuracy of your measurements.

**source field**

In the oscilloscope, the field that allows you to select a channel for edge triggering and trigger level setting.

**state sequence level**

The individual states for the trigger sequencer in the state analyzer. For example, the HP 16550A has twelve states in its trigger sequencer. Each state has a sequence-advance specification and sequence-else specification, which specify the conditions

the analyzer must find to transition from state to state. One of the states is the trigger term (*see* trigger). Each state also specifies the data which the analyzer will store while in that state looking for the sequence-advance and sequence-else specifications.

**storage qualification**

Store qualification allows you to specify the type of information to be stored in memory. Use store qualification to prevent memory from being filled with unwanted activity. When



	<p>you begin to troubleshoot a problem, you will probably want to qualify storage of all activity. As you understand the problem better, you may want to qualify only storage of a routine of interest, or qualify only writes to a variable.</p>	<p>bit or set of bits. <i>See Also</i> pattern terms, range terms, and glitch/edge terms.</p>
<b>terms</b>	<p>Terms are the names of values that can be used in trigger sequences. A term can be a single value on a label or set of labels, any value within a range of values on a label or set of labels, or a glitch or edge transition on a</p>	<p><b>timing sequence levels</b> Similar to state sequence levels. However, the analyzer configuration may be such that there are different numbers of state and timing sequence levels. <i>See also</i> state sequence levels.</p>
	<p><b>toggle field</b></p>	<p>A dark-blue field that has only two options. When you select the field, the current option in that field will change (toggle) to its other option.</p>

**touch-sensitive screen** Any dark-blue field on the screen is a “selectable” field. When you touch a dark-blue field, the field toggles to another option, a pop-up menu appears, or the field turns light-blue to activate the control knob on that field.

**trigger** Trigger is a reference event around which you want to gather information. In the analyzer, you might want to trigger on a glitch in hardware or entry to a subroutine in software. When beginning, you might want to

trigger on the first occurrence of any kind (trigger on “any state”). As you learn more about the problem you are trying to isolate, you may enter more specific trigger conditions. When you want to gather a continuous stream of activity leading up to a system crash, you will want to trigger on “no state.” Note that some microprocessors fetch instructions on 32-bit boundaries. If you are tracing activity of one of these processors,

and you specify trigger on an address that is not on a 32-bit boundary, that address will never appear on the address bus; therefore, the analyzer will never find its trigger. Make sure you specify triggers that the analyzer will find. The state analyzer, timing analyzer, and oscilloscope cannot complete their measurement unless they find a trigger.

**TRIGGER on specification** A kind of sequence-advance specification for the analyzer. When the analyzer finds combination

**trigger point**

**trigger position**

of patterns, occurrences, and time matching the trigger on term, it locks the contents of acquisition memory to this point and fills remaining locations with subsequent states, then stops acquiring data.

In the oscilloscope, the point at which the voltage on the input waveform equals the trigger level voltage value set in the Level field of the trigger menu.

Trigger position specifies where you want the trigger to be

placed in memory.  
“Start” places the trigger at the start of memory and fills the remainder of memory with activity that occurs after the trigger is captured.  
“Center” places the trigger in the center of memory and fills the first half of memory with activity that occurs before the trigger, and the last half of memory with activity that occurs after the trigger.  
“End” places the trigger at the end of memory and fills the remainder of memory with

activity that occurs before the trigger.  
“User-Defined” lets you specify capture of a desired amount of posttrigger activity. Once a trigger is found by a state or timing analyzer, it is identified as the occurrence at analyzer memory location 0. All other states in memory are numbered to show their occurrence relative to the trigger location: states captured before the trigger are numbered with negative numbers (-001, -002,



	etc), and states captured after the trigger are numbered with positive numbers (001, 002, etc).		menu. It is a toggle field that allows you to choose whether to trigger on the selected pattern when it is entered or exited.
<b>vertical position</b>	<i>See</i> offset field.		
<b>V/div</b>	<i>See</i> vertical sensitivity	<b>zooming</b>	In the oscilloscope or timing analyzer, to expand and contract the waveform along the time base by varying the value in the s/Div field. This action allows you to select specific portions of a particular waveform in acquisition memory that will be displayed on the screen. You can view any portion of the waveform record in
<b>vertical sensitivity</b>	In the oscilloscope, the voltage value that determines the amplitude of the waveform on the screen. It is measured in volts per division and is viewed in the V/div field. You change the vertical sensitivity using the knob or the keypad.		
<b>when field</b>	In the oscilloscope, part of the Pattern Mode		

acquisition  
memory.  
Zooming and  
panning are  
useful in  
displaying  
single-shot  
waveforms.





---

# Index

---

## A

Activation record, 1-7  
Address bus, 4-10  
Address ranges, 1-3  
Analyzer  
  concepts, 4-2  
Analyzer problems, 5-3  
  capacitive loading, 5-4  
  intermittent data errors, 5-3  
  no activity on activity indicators, 5-4  
  no setup/hold field on format screen, 5-4  
  unwanted triggers, 5-3  
anystate, 1-5, 2-5, 4-5  
Arm input, 2-2  
Arm level, 1-26  
Arm signal, 1-25  
Arming Control menu  
  See Intermodule Measurements  
ASCII format, 3-16  
  files, 3-16  
Asynchronous interrupt request  
  trigger on, 2-15

## B

Binary format, 3-16  
Branch conditions, 4-4  
Bus contention, 1-23

## C

Cautions  
  power down analyzer and target system, 5-2  
Chip select lines, 2-20  
Configuration tree  
  arming modules, 2-5  
Control signals, 1-26  
Coprocessor systems  
  debugging, 2-20  
Cross arming  
  See Intermodule Measurements

## D

Data  
  triggering on bad, 1-11  
Data bus, 4-10  
Data files  
  in ASCII format, 3-16  
  in binary format, 3-16

## E

else-if branch, 4-5  
Encapsulated PostScript files, 3-10  
Entry address, 1-3  
Error Messages, 5-12  
External instrument  
  starting or stopping, 2-9

## F

Falling edge, 2-7  
File description, 3-4  
File management, 3-2  
File manager, 3-18  
File name, 3-4  
First statement, 1-3  
Flexible disk, 3-8  
Flexible disk actions, 3-3  
Function entry triggering, 1-9

## G

Glitch detection  
  "\*\*, 2-13 to 2-14  
  timing analyzer, 2-13  
Glitch waveforms, 2-2, 2-14  
Graphics files  
  B/W TIF, 3-10  
  color TIF, 3-10  
  EPS, 3-10  
  PCX, 3-10  
  transferring, 3-18  
Graphics images, 3-10  
Ground bounce, 2-13  
Group boundaries, 4-8  
Group Run Armed from PORT IN field, 2-7  
Group Run field, 2-4  
Group Run tree  
  arming modules, 2-5  
Group runs, 2-7  
Groups, 4-7

## H

Handshake violation, 1-22

## I

I/O activity, 2-20  
if branch, 4-4  
Independent clocks, 2-22  
Independent lookup, 4-12  
Independent modules, 2-5  
Initialization code, 1-7  
Interleaved trace lists, 2-21  
Intermodule bus arming signals, 2-2  
Intermodule Measurement problems, 5-11  
  an event wasn't captured, 5-11  
Intermodule Measurements, 2-2  
  adjust for minimum skew, 2-28  
  independent state and timing analyzers, 2-13  
  seeing the status of a module, 2-11  
  time correlation, 2-12  
Intermodule menu, 2-4  
Internal clock, 2-12  
Interrupt processing, 2-15  
Invasm key, 4-10  
Inverse assembler, 4-2, 4-10  
Inverse Assembler problems, 5-9  
  incorrect inverse assembly, 5-9  
  inverse assembler will not load or run, 5-10  
  no inverse assembly, 5-9

## L

LAN Interface files, 3-13  
Loop iteration triggering, 1-5

## M

Manual acquisition mode, 2-13  
Masked interrupts, 2-15  
Maximum states, 4-3  
Measurement configurations  
  loading, 3-6  
  saving, 3-4  
Menus  
  saving as graphics images, 3-10  
Minimum states, 4-3  
Mixed Display mode, 2-21  
Module delays  
  skew adjustment accuracy, 2-26  
Modules  
  Running status, 2-11  
  status interpretation, 2-11  
  Stopped status, 2-11



**N**

NFS node, 3-13  
 no state, 1-3, 4-5  
 Non-reference channel, 2-26  
 not, 4-5

**O**

Onscreen keypad, 2-7  
 Output Disk menu, 3-8  
 Output Format field, 3-8

**P**

Pair boundaries, 4-8  
 Pairs, 4-7  
 Pattern expression, 4-7  
 Pattern generators, 2-17  
 Pattern terms, 4-6  
 PC Paintbrush files, 3-10  
 Pipelining  
   add depth to start address, 1-4  
 PORT IN BNC connector, 2-7  
 PORT IN BNC level, 2-7  
 PORT IN/OUT Field, 2-7  
 Port input line, 2-2  
 PORT OUT choices, 2-9  
 Preprocessor problems, 5-6  
   erratic trace measurements, 5-7  
   slow clock, 5-7  
   target system will not boot up, 5-6  
 Print to disk, 3-18  
 Problems, 5-2  
 Product Notes, 6-2  
 Pulse limits  
   test minimum and maximum, 1-20

**R**

Range terms, 4-6  
 Rear panel input signal, 2-7  
 Recursive call triggering, 1-7  
 Reference channel, 2-26  
 Registers  
   verifying correct storage, 1-13  
 Repetitive measurements  
   automating, 3-4  
 Resources, 4-7  
 Rising edge, 2-7

**S**

Saving  
   menus or measurements as graphics images, 3-10  
   to a flexible disk or internal drive, 3-4  
 Screen display  
   graphics files, 3-18  
 Screen images, 3-2  
 Secondary branch, 4-5  
 Sequence-advance specification, 1-2  
 Sequence-Else specification, 1-2  
 Sequential trigger, 1-2  
 Set up  
   HP 16500B, 3-14  
 Signals  
   inserting and deleting, 2-24  
 Skew, 2-26  
   adjust for minimum, 2-28  
   comparison, 2-28  
   removal, 2-28  
   testing signal, 2-27  
 Stacks  
   verifying correct storage, 1-13  
 Start state, 4-10  
 State analyzer  
   invalid combinations, 4-8  
   valid combinations, 4-8  
 State analyzers  
   using two to monitor coprocessors, 2-20  
 State flow, 2-15  
 State listings  
   inserting, 2-24  
 State sequence level, 1-2  
 Status, 4-10  
 Status signals, 1-26  
 Stimulus response, 2-17  
 Store qualification, 1-2  
 Storing  
   configuration files, 3-2  
 Subroutine execution  
   storing and timing, 1-3  
 Subroutines  
   triggering on execution, 1-3  
   verifying storage before exiting, 1-13  
 Symbols, 4-12  
 Synchronization, 4-10

**T**

Test PC boards  
   when no board-test system is available, 2-17  
 TIFF files, 3-10  
 Time  
   counted implicitly, 2-24  
 Time correlation, 2-12  
 Time correlation bars, 2-12  
 Time markers, 2-24  
 Time stamps, 2-22  
 Timer Control Field, 1-12, 1-18  
 Timers, 4-6  
 Trace lists  
   indented line numbers, 2-22  
   interleaving, 2-20 to 2-22  
   saving in ASCII format, 3-8  
   viewing with waveforms, 2-25  
 Transferring  
   graphics files, 3-18  
 Trigger sequencer, 4-2 to 4-3  
 Trigger term, 4-5  
 Triggering  
   after status bus lines finish transitioning, 1-15  
   menus, 1-2  
   on a count down of a set of data lines, 2-19  
   on a handshake violation, 1-22  
   on a loop that runs too long, 1-12  
   on a timing violation, 1-25  
   on anything, 2-7  
   on asserting chip select lines, 1-16  
   on bad data, 1-11  
   on bus contention, 1-23  
   on control and status signals, 1-26  
   on entry to a function, 1-9  
   on interrupt request, 2-15  
   on loop iteration, 1-5  
   on pulse limits, 1-20  
   on recursive function call, 1-7  
   on subroutine execution, 1-3  
   on the arm signal, 2-7  
   when expected data does not appear, 1-18  
 Triggers  
   position at any state, 2-13

**V**

Verifying

- chip select line is strobed, 1-17
- correct execution, 1-3
- correct storage, 1-13
- efficiency, 1-3

Viewing

- trace lists and waveforms together, 2-25

**W**

Watchdog timer behavior, 2-20

Waveforms

- deleting, 2-27
- inserting, 2-27
- viewing with trace lists, 2-25



---

Hewlett-Packard  
P.O. Box 2197  
1900 Garden of the Gods Road  
Colorado Springs, CO 80901

